



### Letter-Sound Match

#### Objective

The student will match initial, final, and medial phonemes to graphemes.

#### Materials

- ▶ Picture cards
- Note: The pictures used are: ant, map, pin, bib, bug, dog, cry, leg, fly, sun*
- ▶ Student sheet
- ▶ Scissors
- ▶ Glue

#### Activity

Students sort pictures by matching phonemes to graphemes and write missing letters.

1. Provide the student with a student sheet and picture card Activity Master. Place scissors and glue at the center.
2. The student cuts out the pictures. Selects a picture, names it, and says each sound (e.g., “bug, /b//u//g/”).
3. Looks for the letters that correspond to two of the sounds.
4. Glues the picture in the fourth column next to the two letters. Looks at the blank space in the row, determines the missing sound, and writes the corresponding letter (i.e., “/b//u//g/, the missing letter is g”).
5. Continues until all blanks are filled.
6. Teacher evaluation

**Name** \_\_\_\_\_

Letter-Sound Match P.025

|   |   |   |         |
|---|---|---|---------|
| m |   | p | picture |
|   | i | n | picture |
| b | u |   |         |
| a |   | t | picture |
| b | i |   | picture |
| s | u |   | picture |
| c |   | y | picture |
|   | e | g | picture |
| f |   | y | picture |
|   | o | g | picture |

©2005 The Florida Center for Reading Research (Florida 2005) © The Student Center Activities Program

#### Extensions and Adaptations

- ▶ Use other pictures and words.

©2005 The Florida Center for Reading Research and Florida Department of Education (Revised, 2021)

K-I Student Center Activities: Phonics

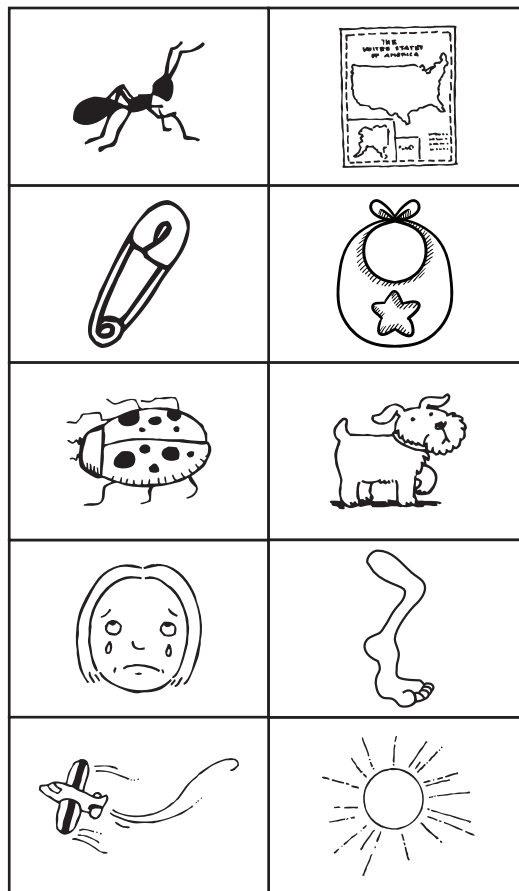

# Phonics

Letter-Sound Match

P. 025

|   |   |   |         |
|---|---|---|---------|
| m |   | p | picture |
|   | i | n | picture |
| b | u |   | picture |
| a |   | t | picture |
| b | i |   | picture |
| s | u |   | picture |
| c |   | y | picture |
|   | e | g | picture |
| f |   | y | picture |
|   | o | g | picture |

|  |  |  |         |
|--|--|--|---------|
|  |  |  | picture |
|  |  |  | picture |
|  |  |  | picture |
|  |  |  | picture |
|  |  |  | picture |
|  |  |  | picture |
|  |  |  | picture |
|  |  |  | picture |
|  |  |  | picture |
|  |  |  | picture |
|  |  |  | picture |

# Phonics

Letter-Sound Match

P. 025

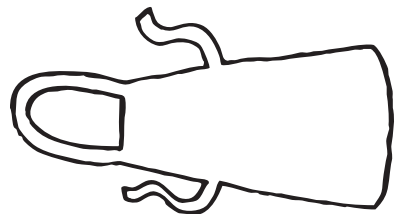
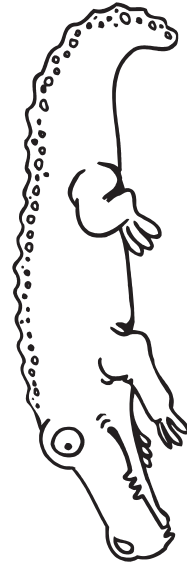
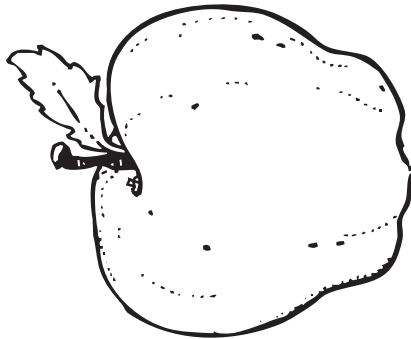
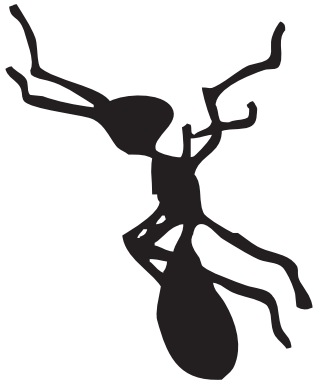

ant, apple, alligator, ax, ape, apron

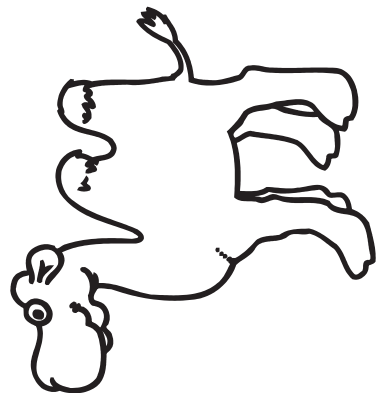
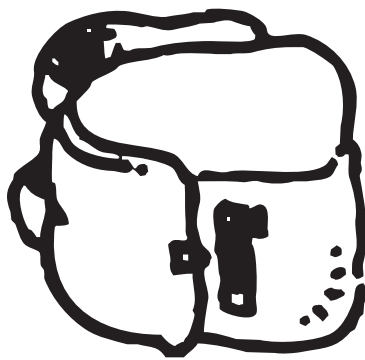
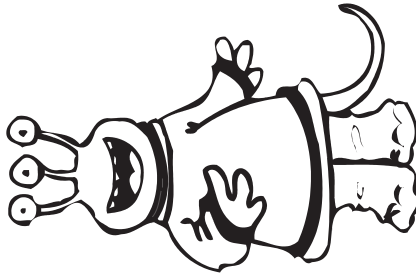
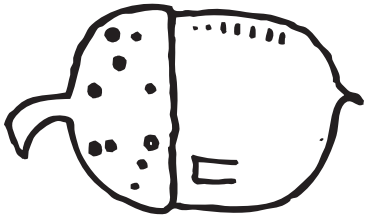

acorn, alien, beach, banana, backpack, camel

# Phonics

Letter-Sound Match

P. 025

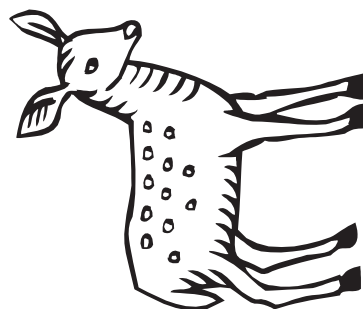
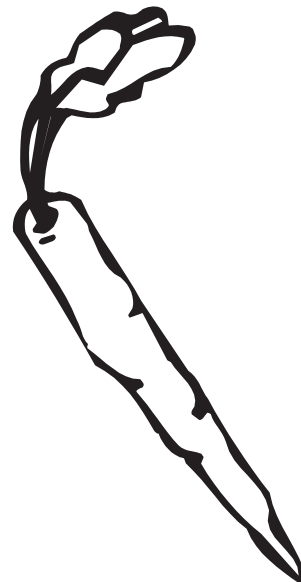
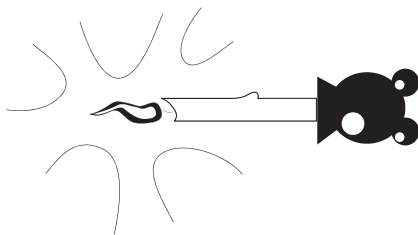

cane, candle, carrot, doughnut, dragon, deer



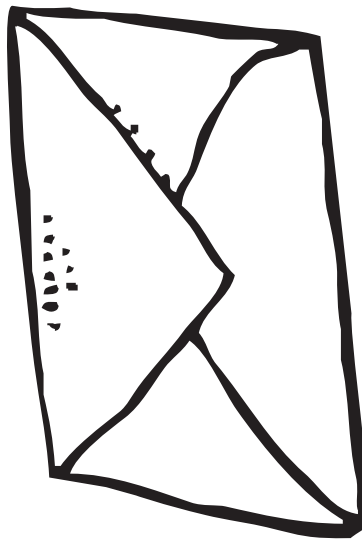
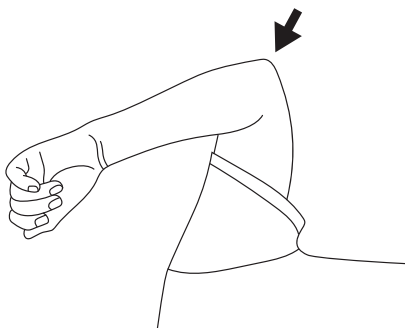
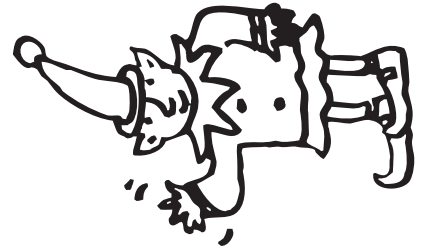
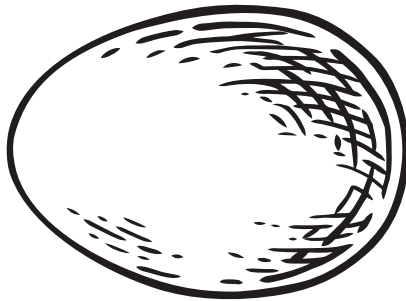
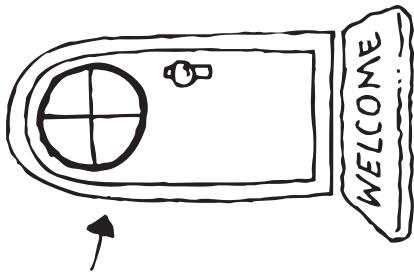

$$2 + 2 = 4$$

An arrow points to the equals sign in the equation.

door, egg, elf, elbow, envelope, equal





# Phonics

Letter-Sound Match

P. 025

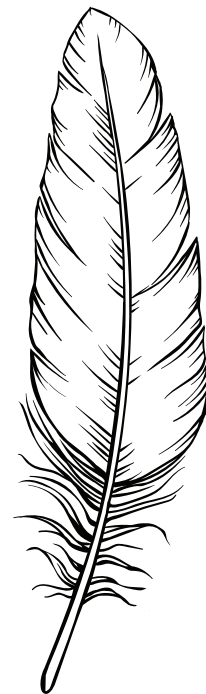
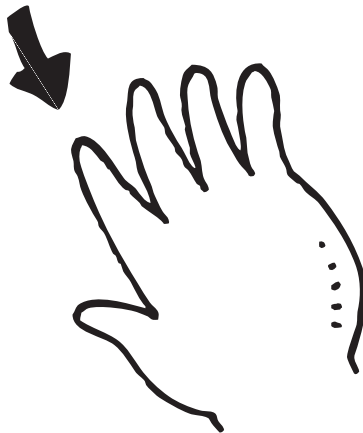
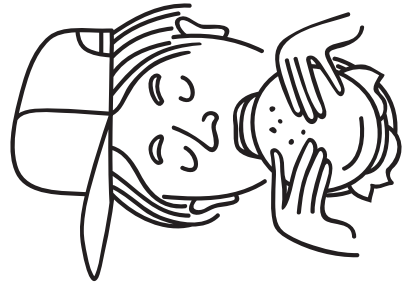
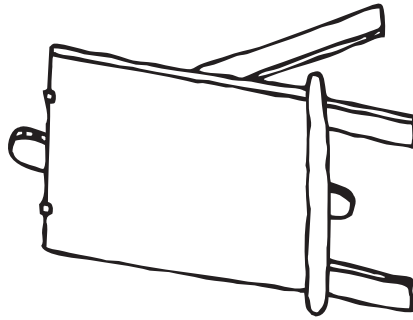

eagle, easel, eat, four, finger, feather



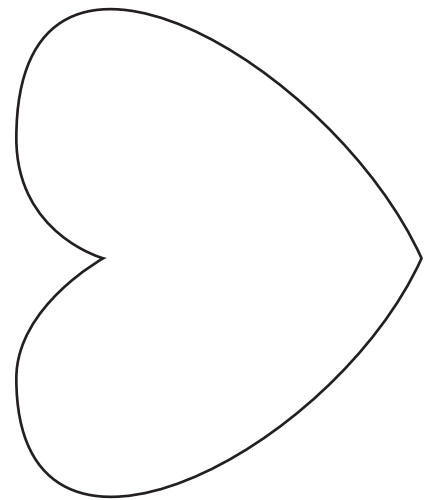
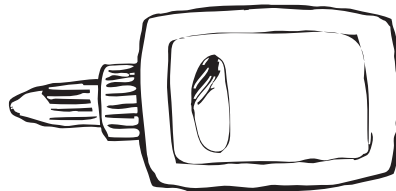
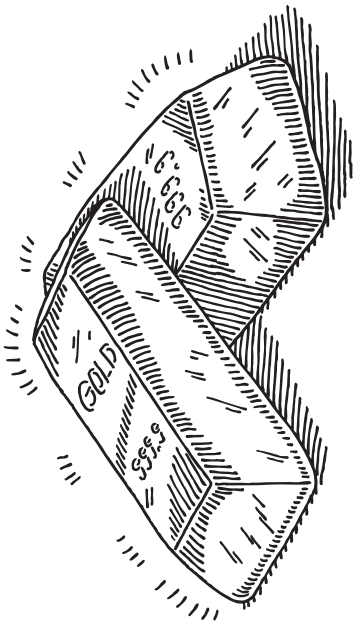
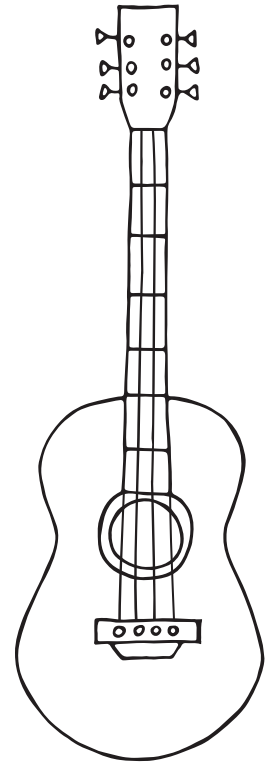
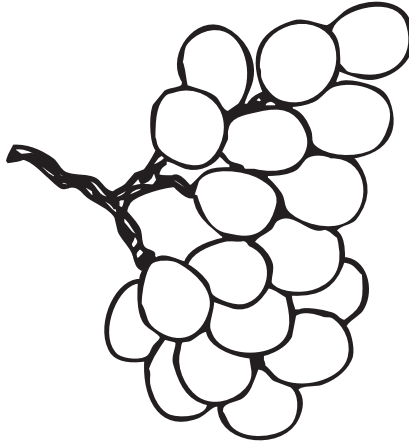
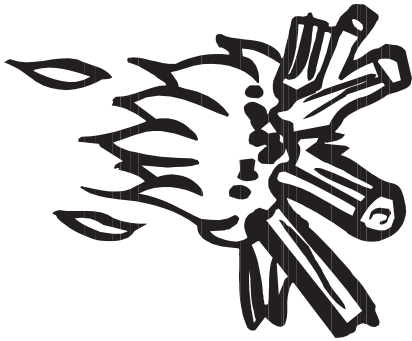

fire, grapes, guitar, gold, glue, heart



# Phonics

Letter-Sound Match

P. 025

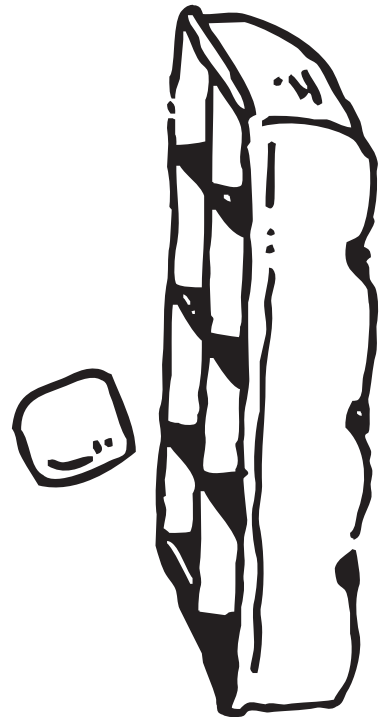
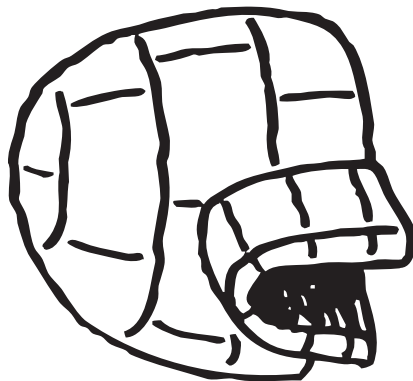
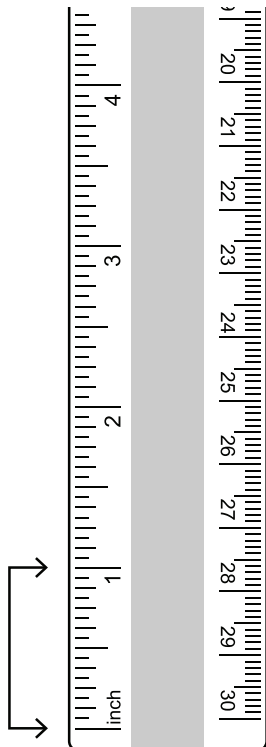
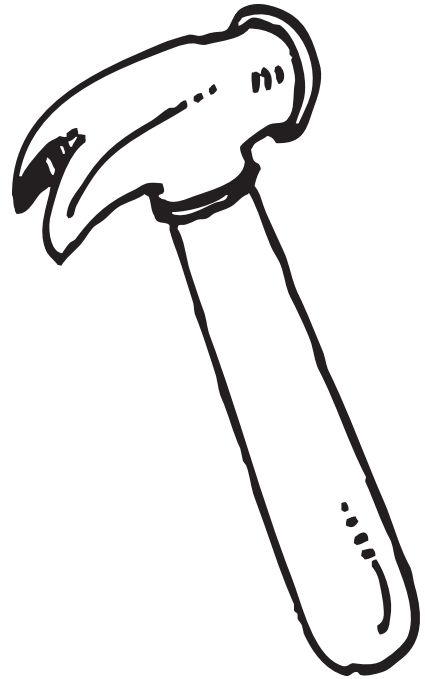
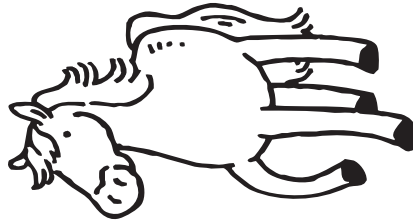

hippopotamus, horse, hammer, inch, igloo, ice



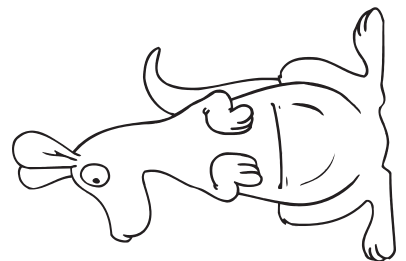
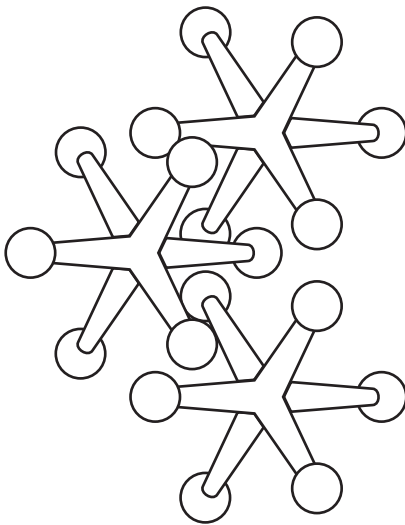
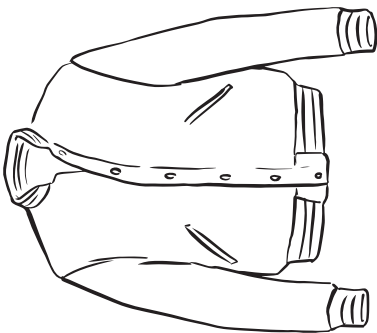
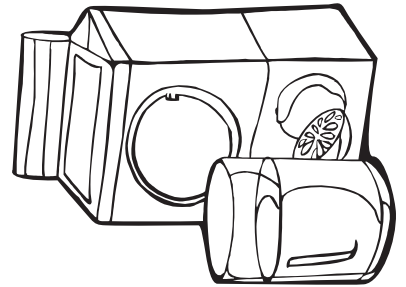
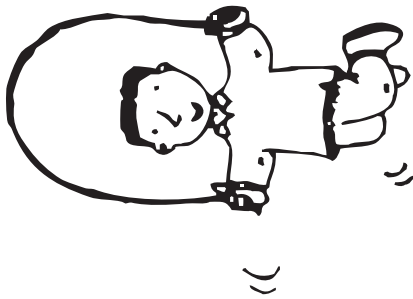
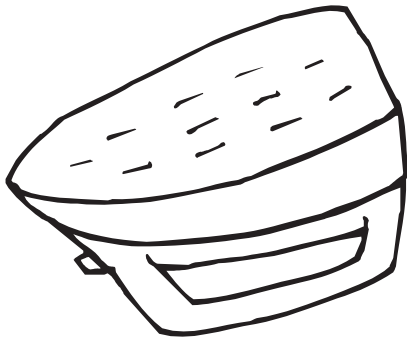

iron, jump, juice, jacket, jacks, kangaroo



# Phonics

Letter-Sound Match

P. 025

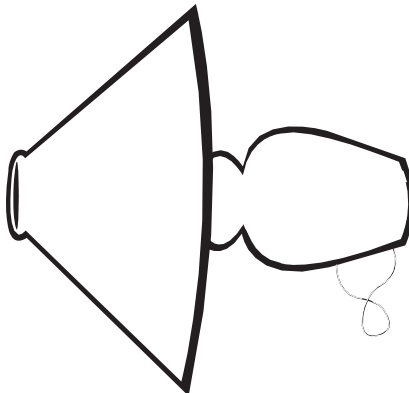
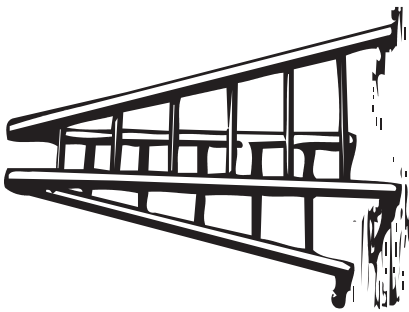
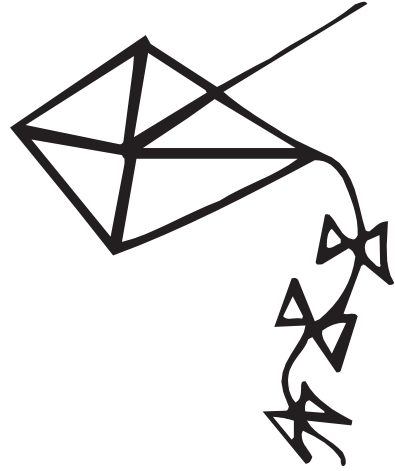
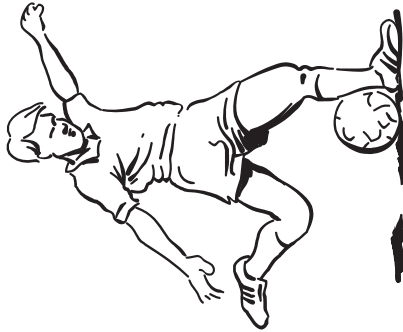

key, kick, kite, ladder, lamp, lion



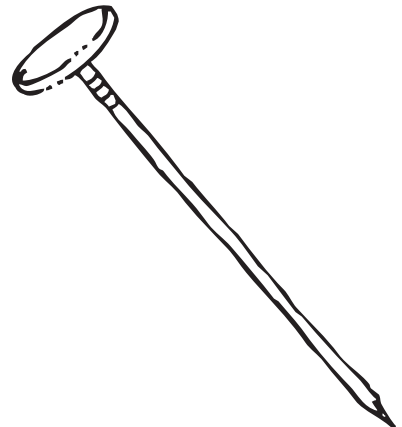
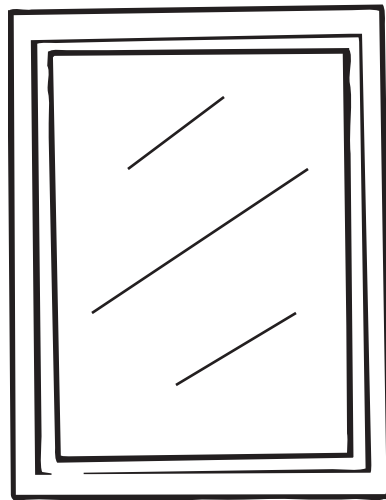
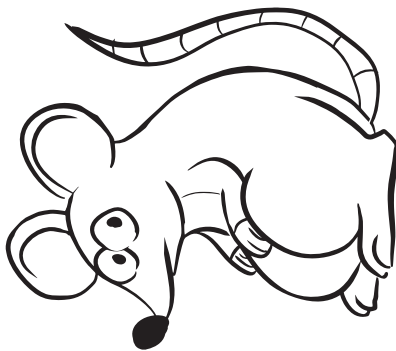
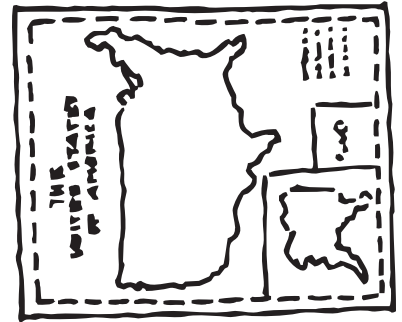
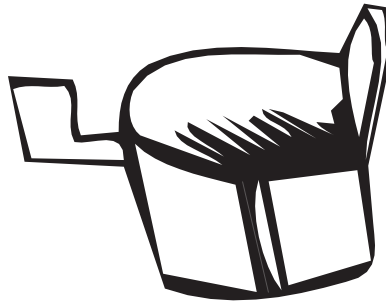
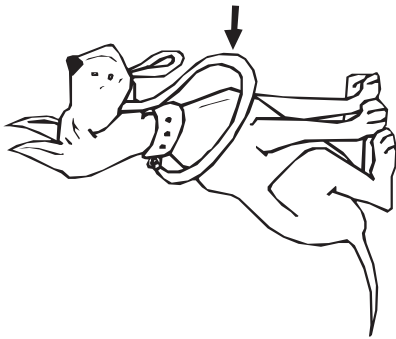

leash, mailbox, map, mouse, mirror, nail



# Phonics

Letter-Sound Match

P. 025

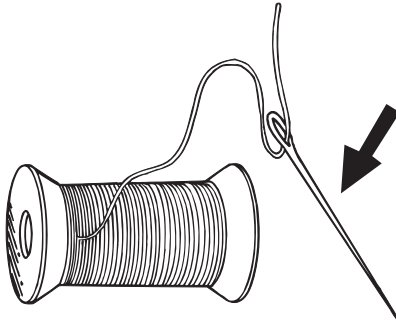
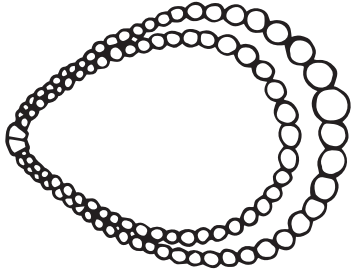

necklace, needle, nurse, octopus, ox, olive



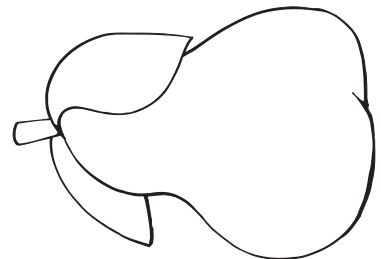
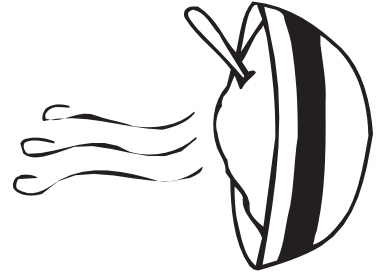
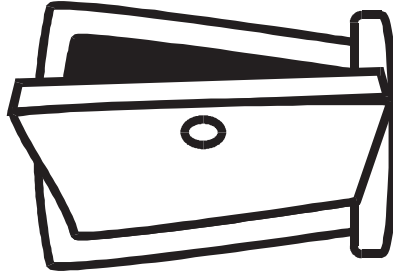

ostrich, open, oatmeal, pretzel, pillow, pear





# Phonics

Letter-Sound Match

P. 025

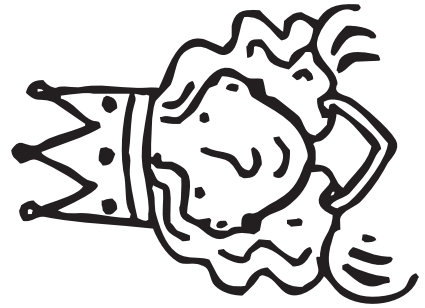
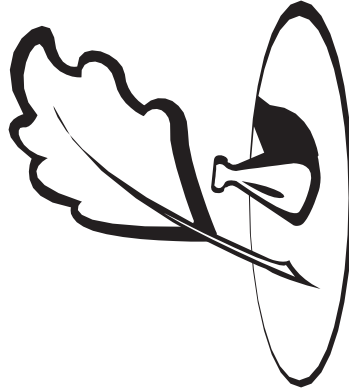
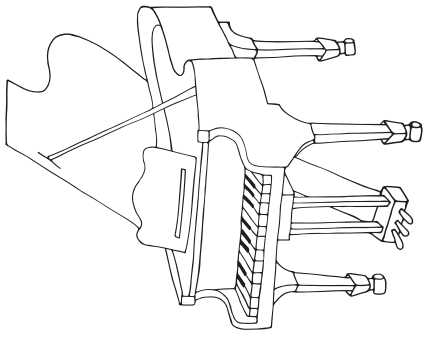

piano, quill, queen, question, quarter, rabbit



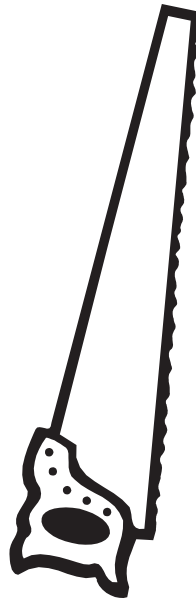
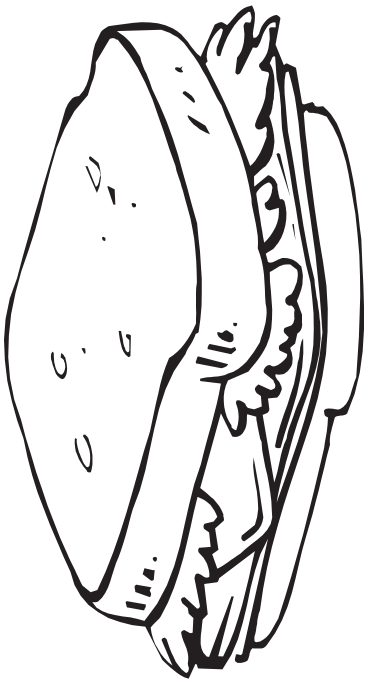
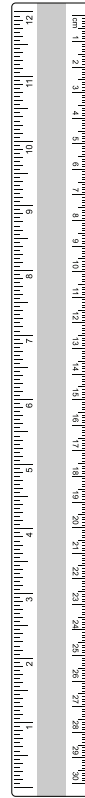
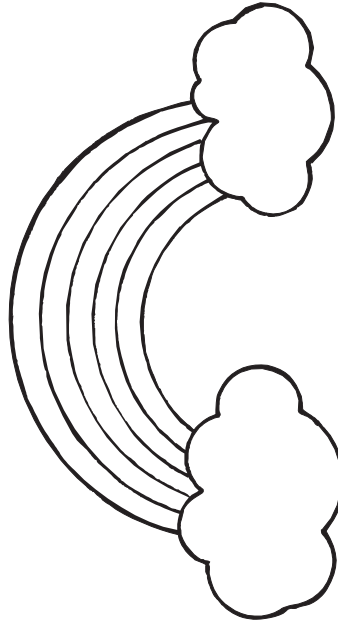
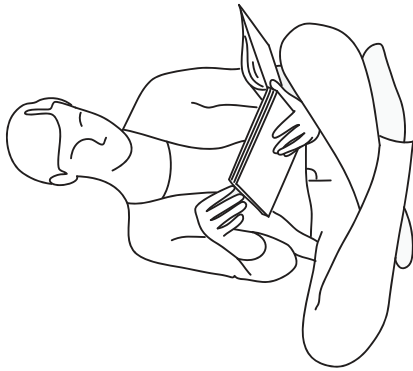

read, rainbow, ruler, sandwich, saw, seven

# Phonics

Letter-Sound Match

P. 025

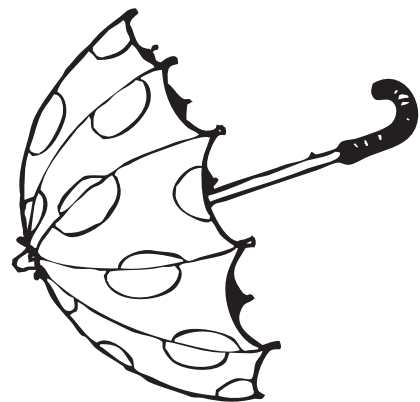
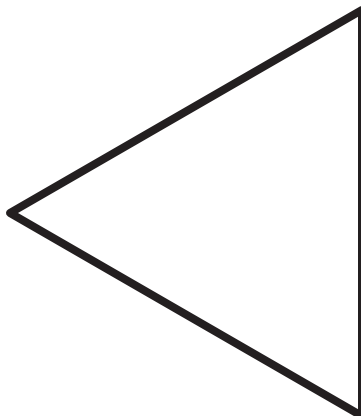
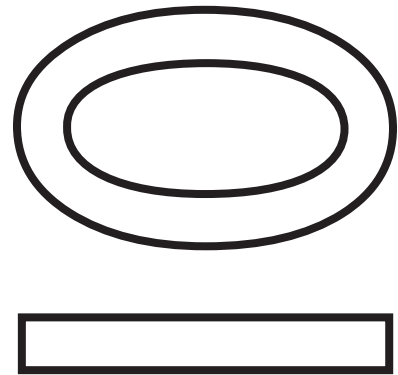
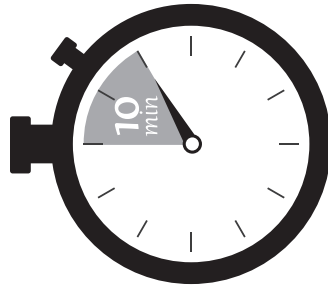

snake, timer, ten, tire, triangle, umbrella



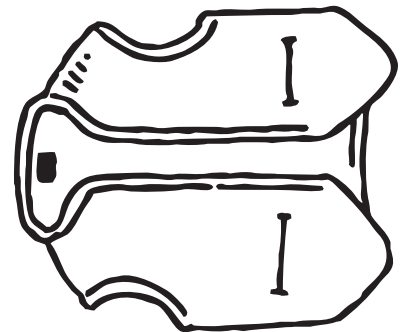
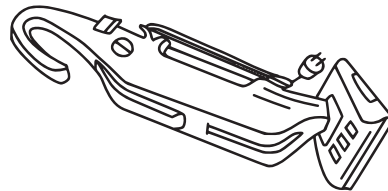
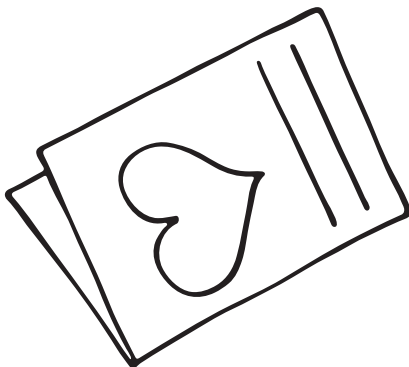
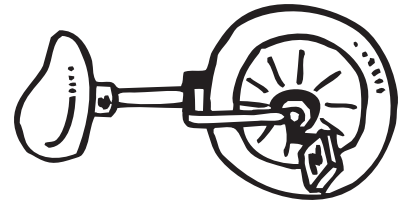
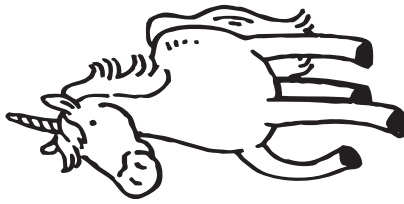

umpire, unicorn, unicycle, valentine, vacuum, vest



# Phonics

Letter-Sound Match

P. 025

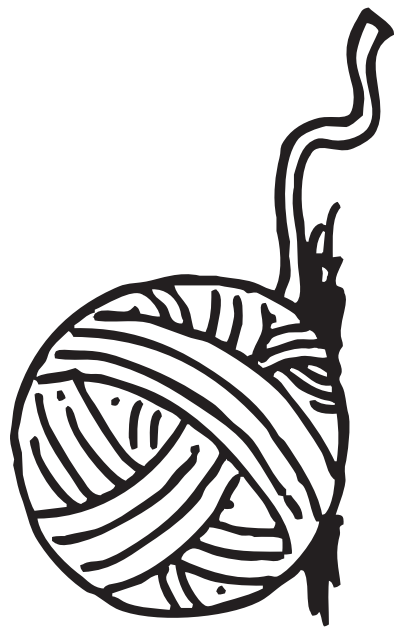
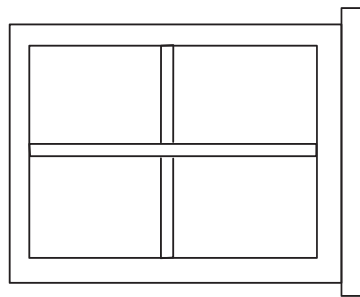
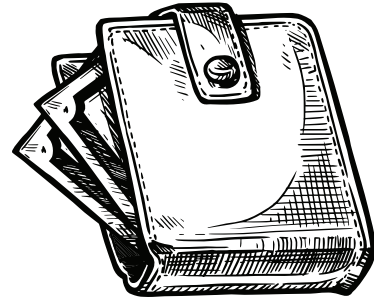
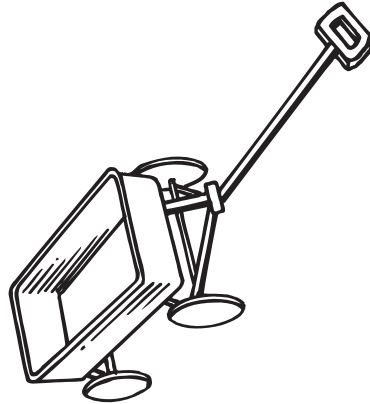
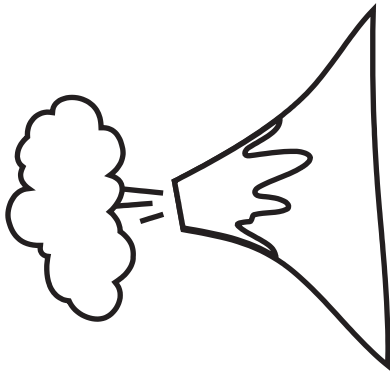

volcano, wagon, wallet, watch, window, yarn



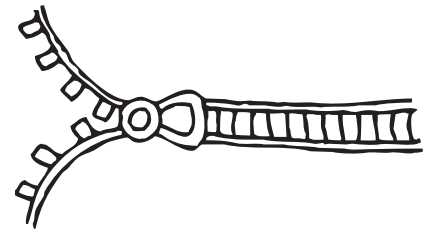
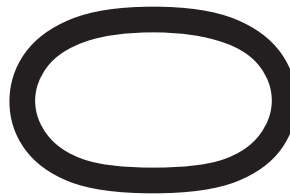
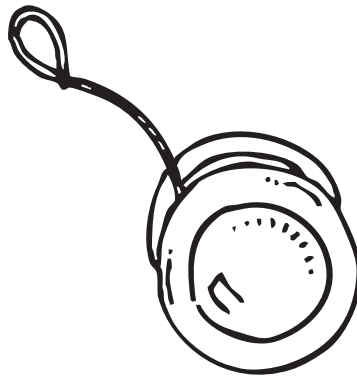

yawn, yo-yo, yak, zebra, zero, zipper



# Phonics

Letter-Sound Match

P. 025

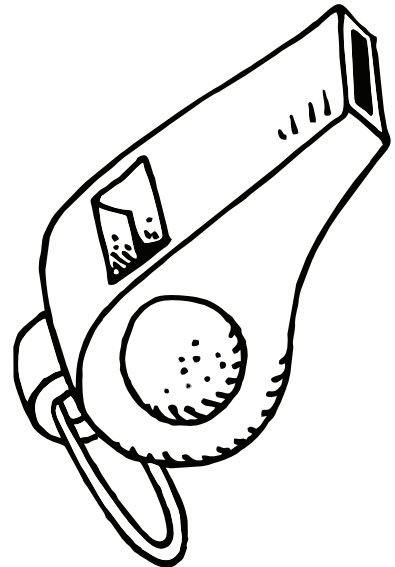
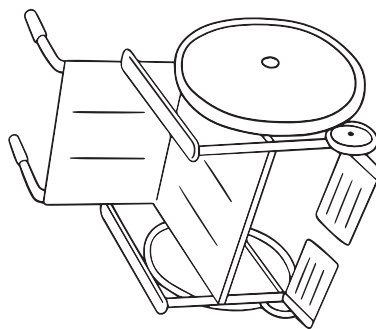
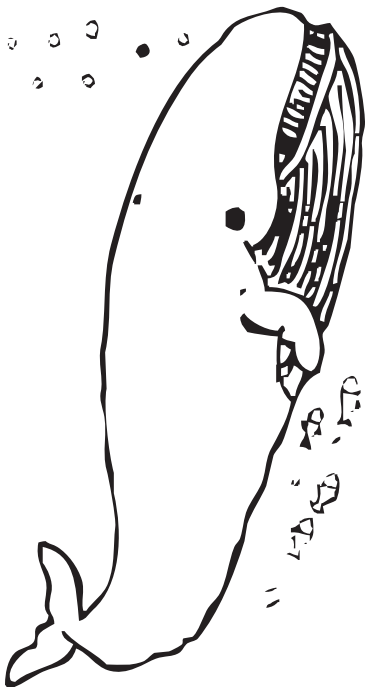
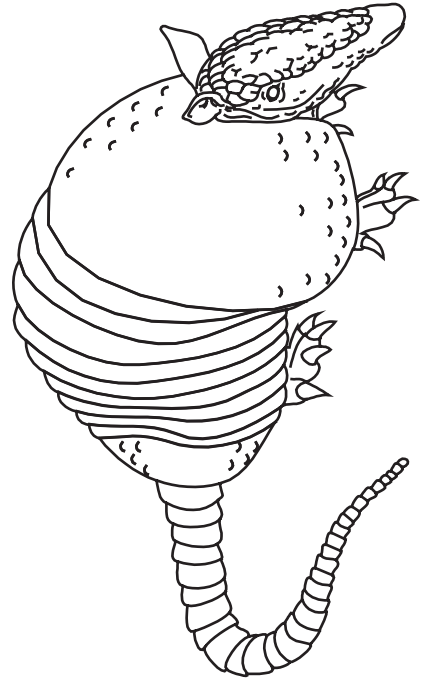
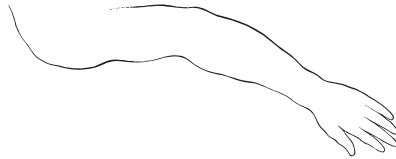

zoo, arm, armadillo, whale, wheelchair, whistle



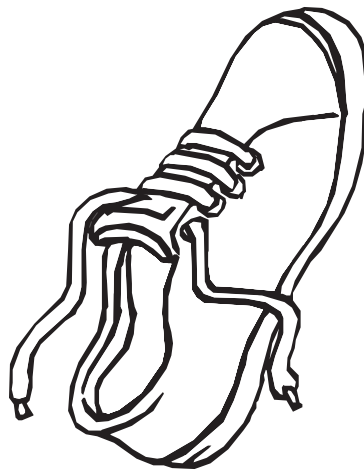
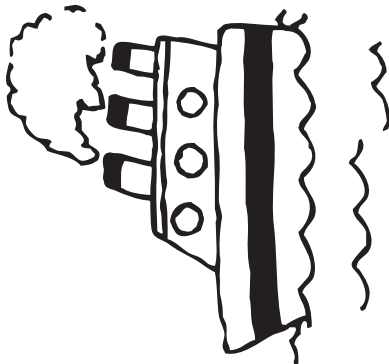
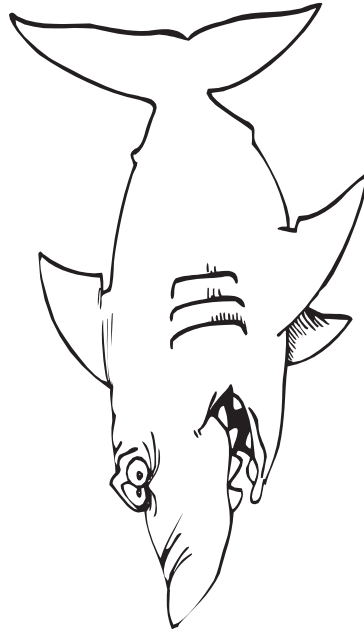
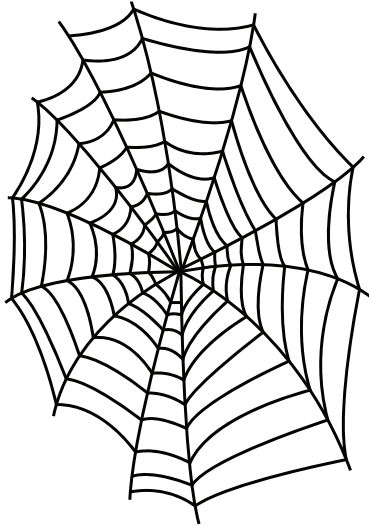

web, shark, shell, ship, shoe, thermometer





# Phonics

Letter-Sound Match

P. 025

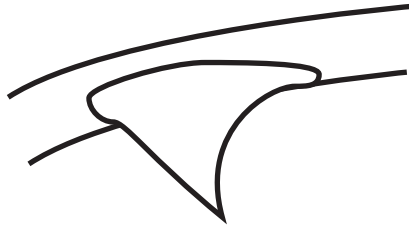
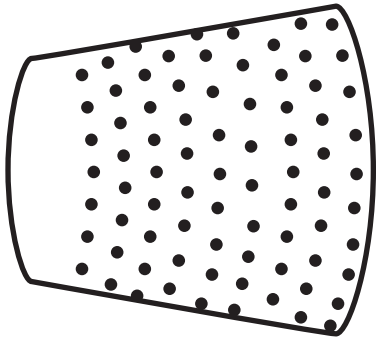

30

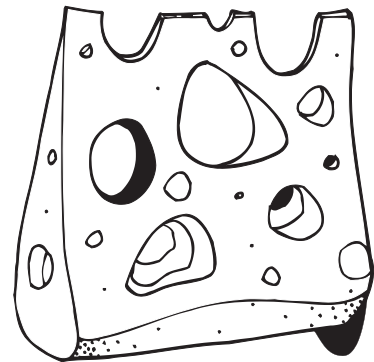
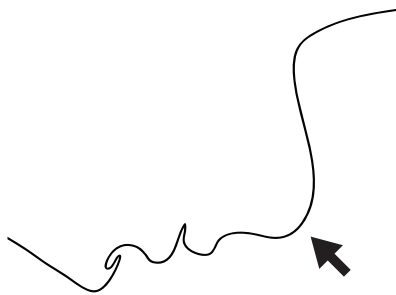
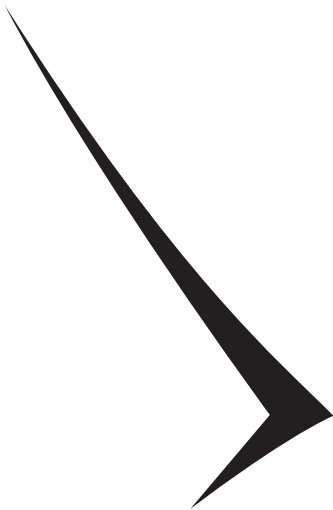

thimble, thorn, thirty, check, chin, cheese



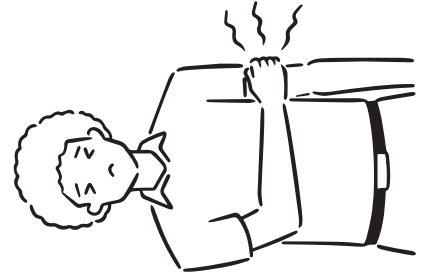
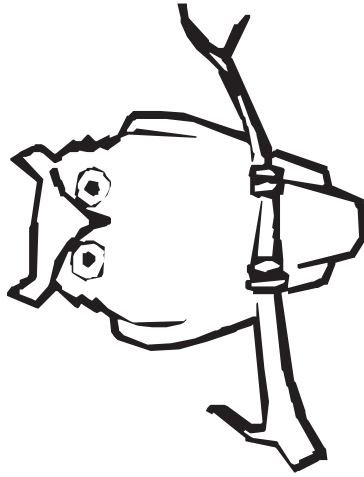
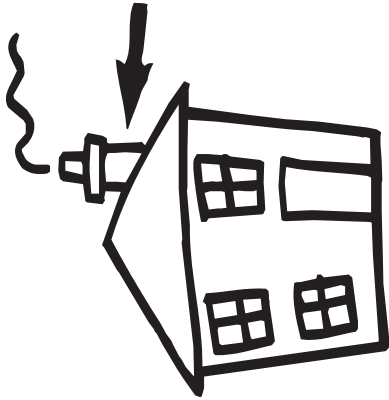

chimney, owl, ouch



# Phonics

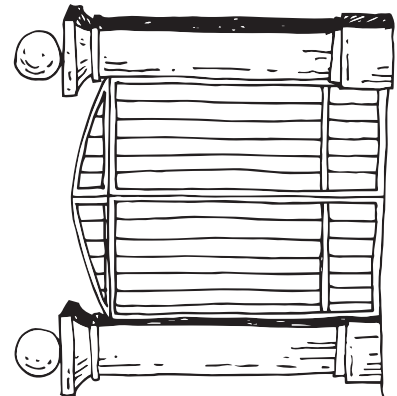
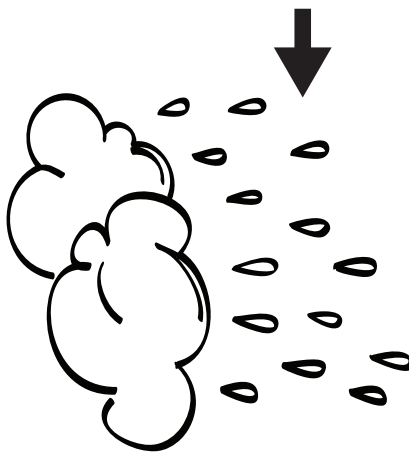
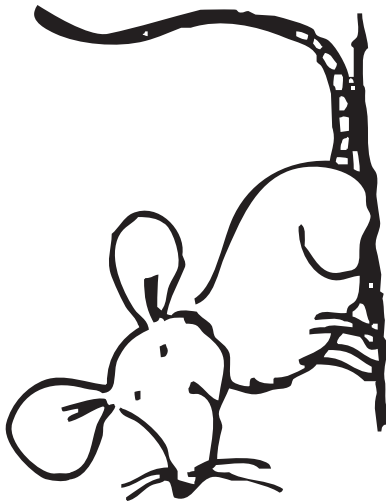
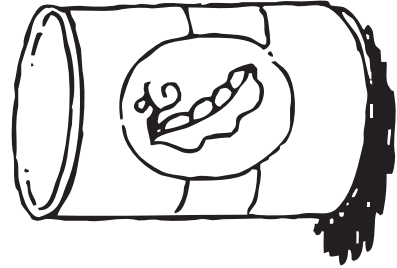
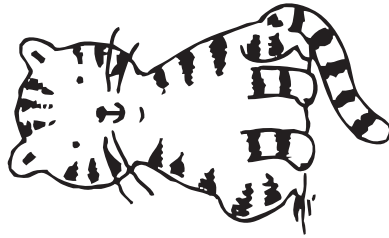
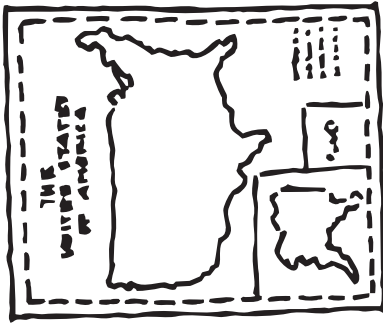

Letter-Sound Match

P. 025



map, cat, can, rat, rain, gate

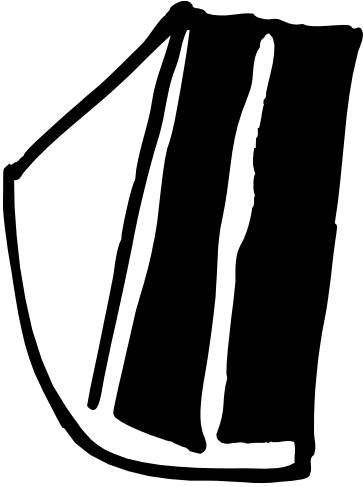
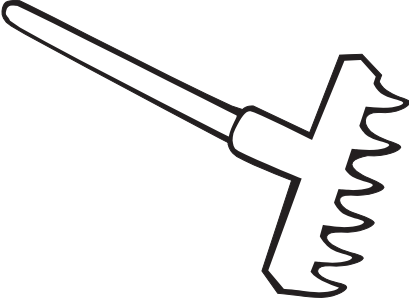

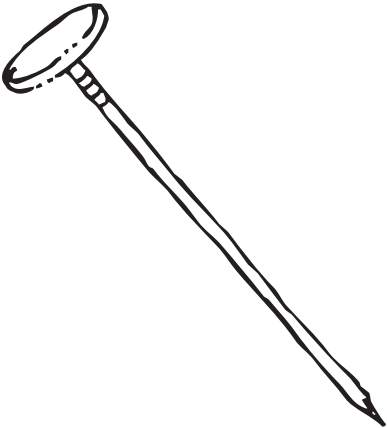
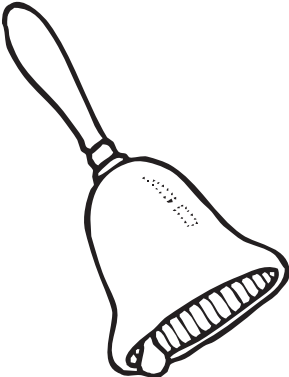
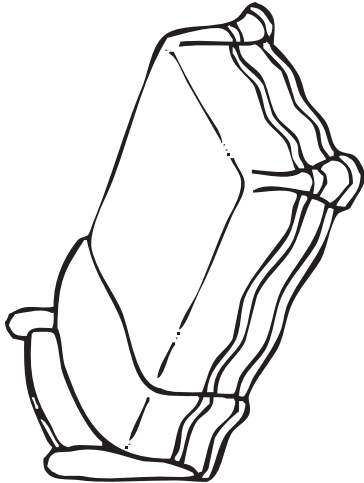
|   |   |   |
|---|---|---|
|    |   |    |
|  |  |  |

cake, rake, cane, nail, bell, bed



# Phonics

Letter-Sound Match

P. 025

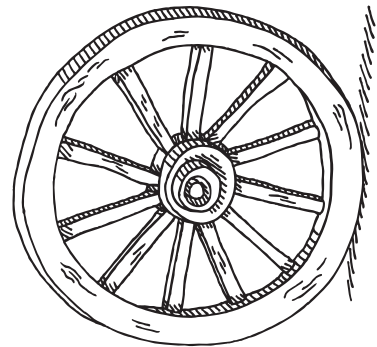
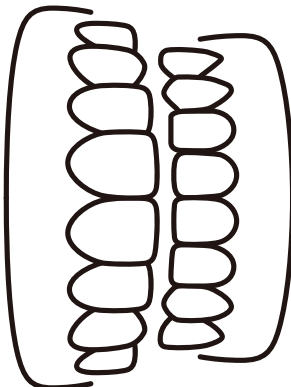
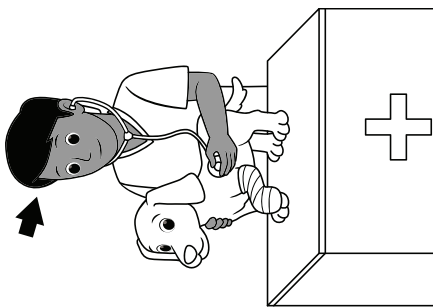
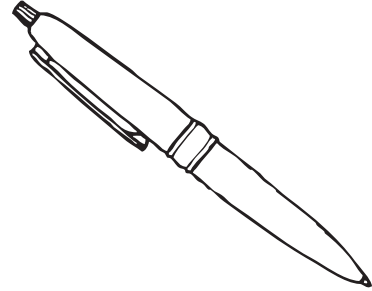
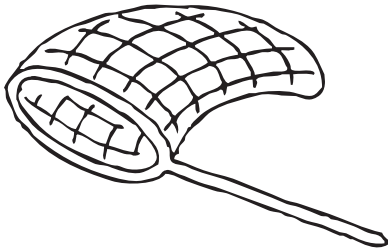

net, men, pen, vet, teeth, wheel



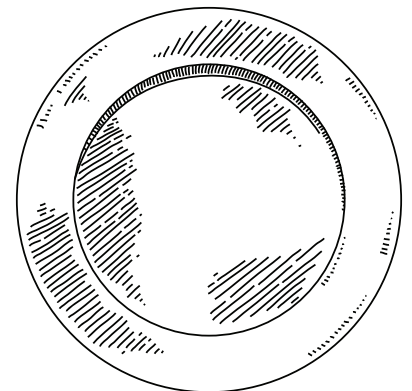
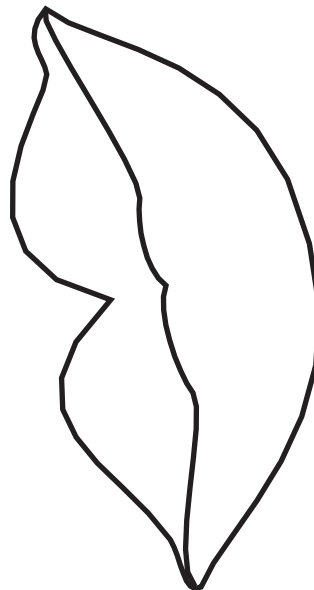
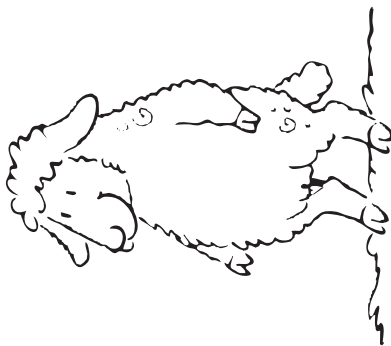
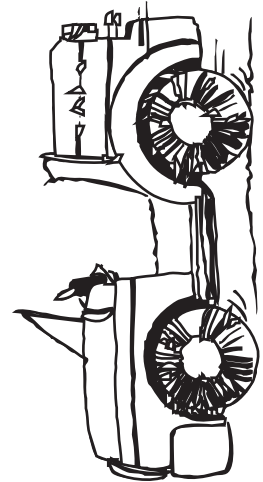
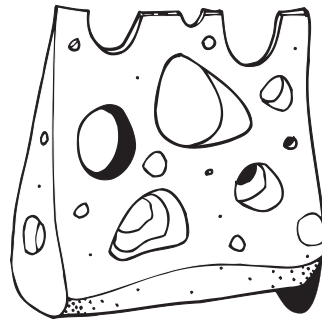
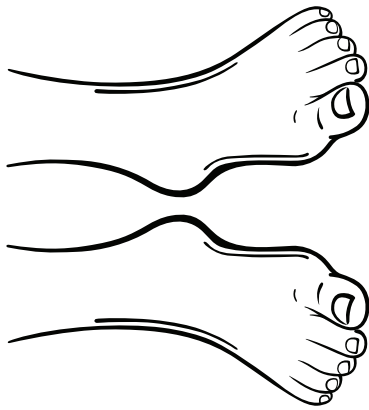

feet, cheese, jeep, sheep, lip, dish



# Phonics

Letter-Sound Match

P. 025

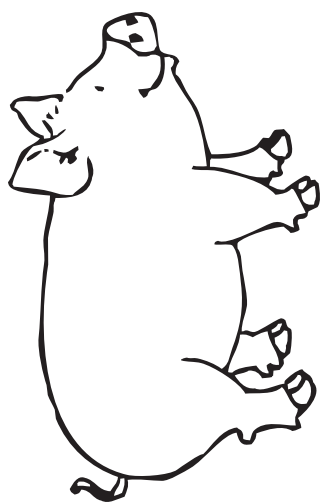
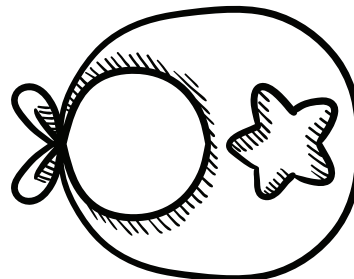
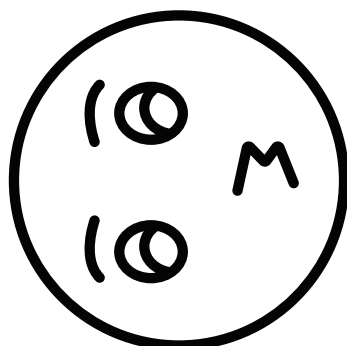
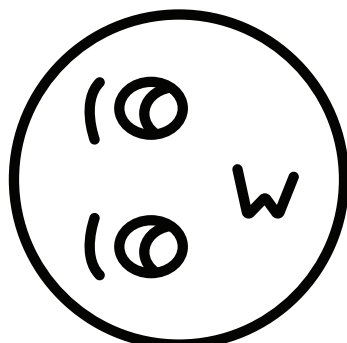
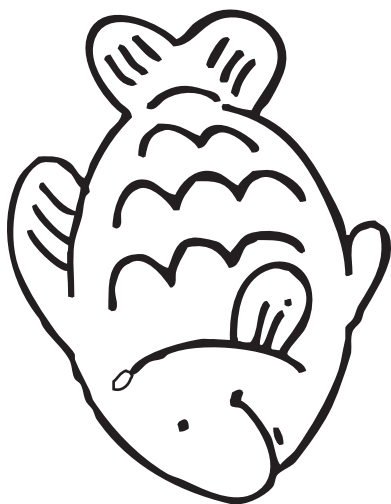

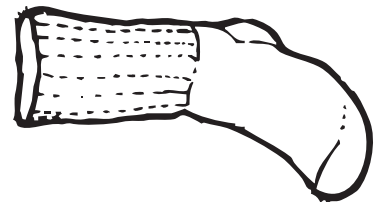
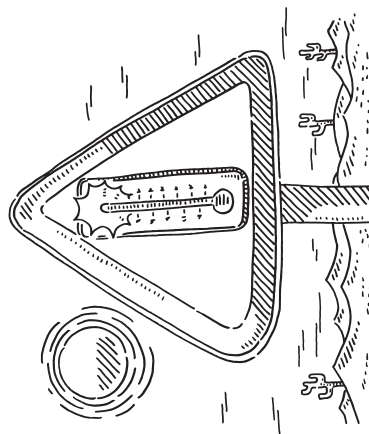
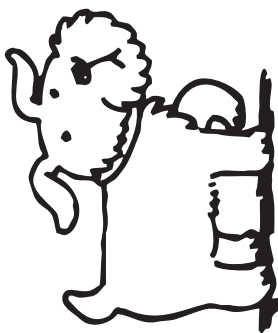
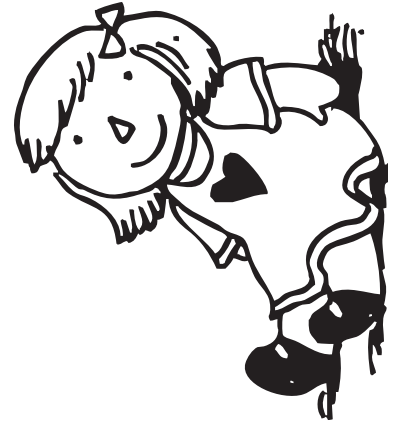
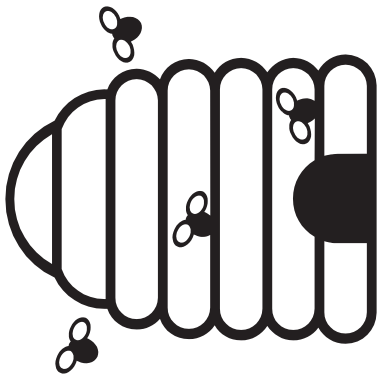

hive, mice, doll, dog, hot, sock





# Phonics

Letter-Sound Match

P. 025

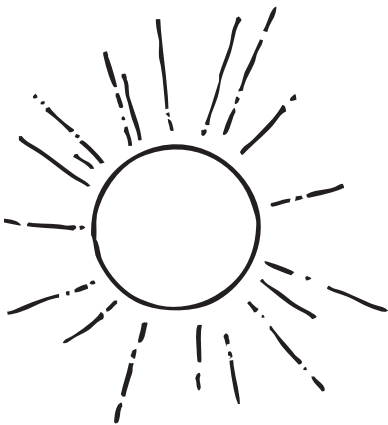
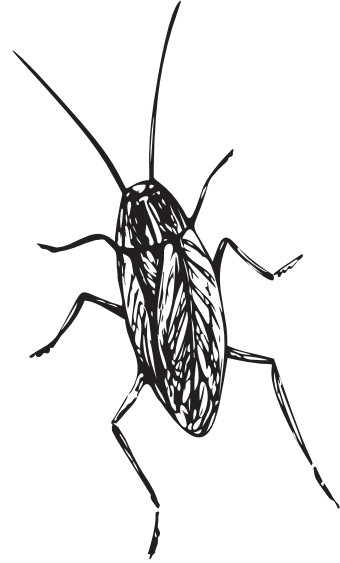
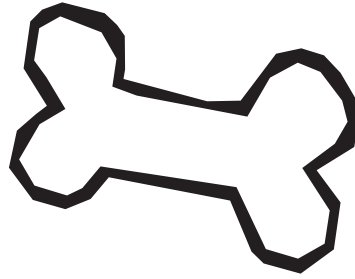
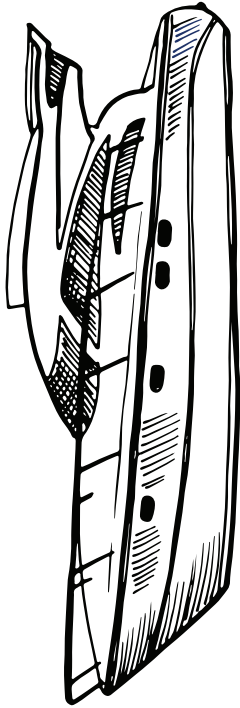

boat, bone, roach, sun, duck, rug



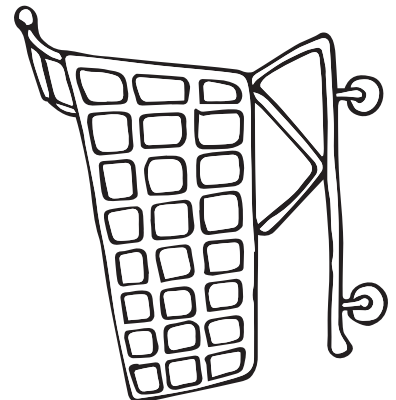
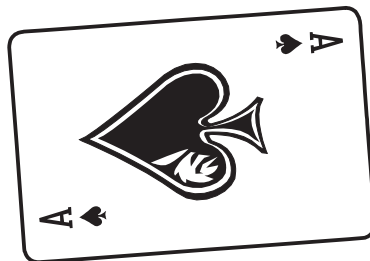
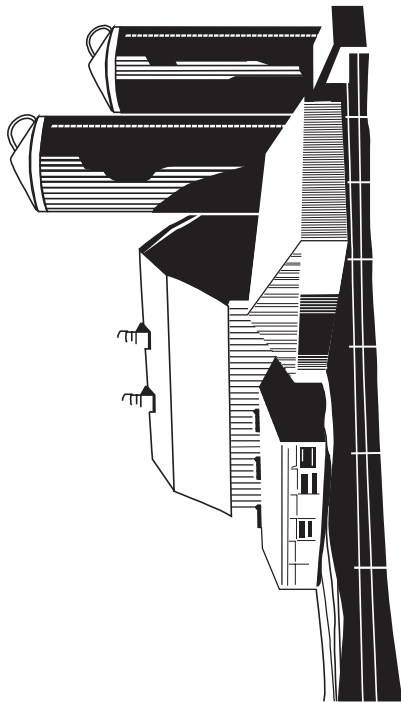
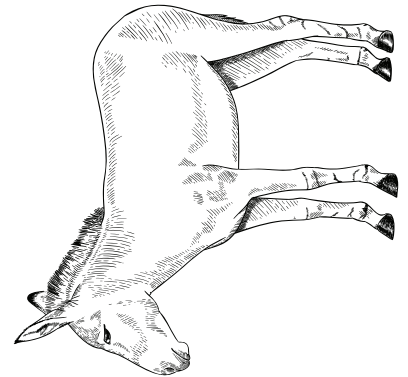
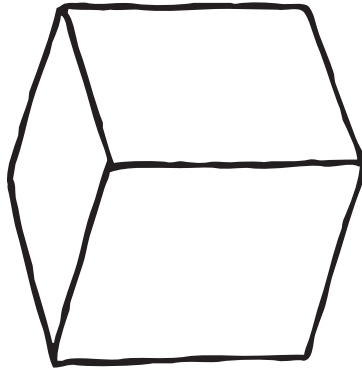
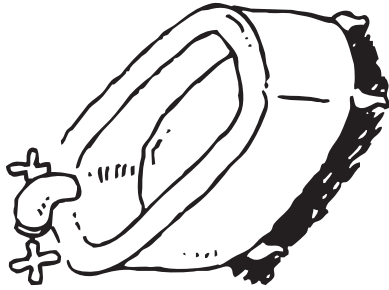

tub, cube, mule, farm, card, cart



# Phonics

Letter-Sound Match

P. 025

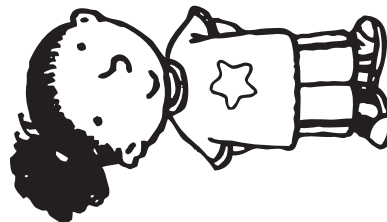
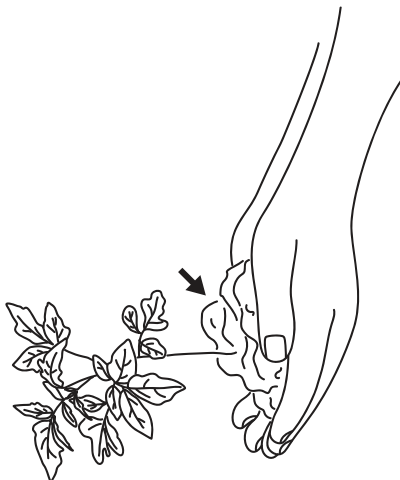
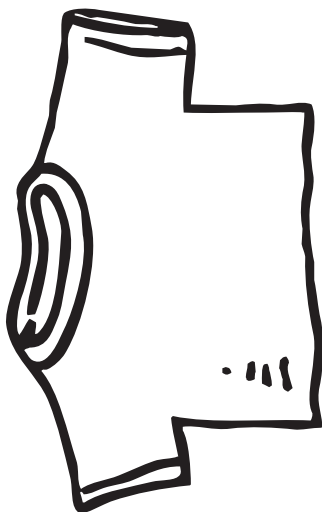
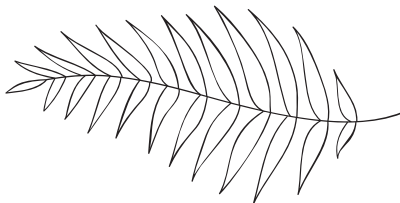
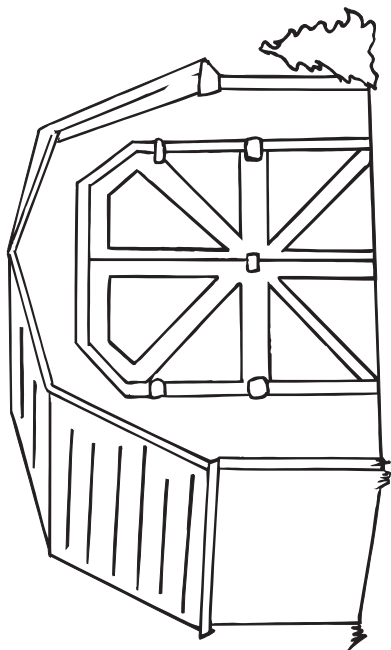

barn, fern, bird, shirt, dirt, girl



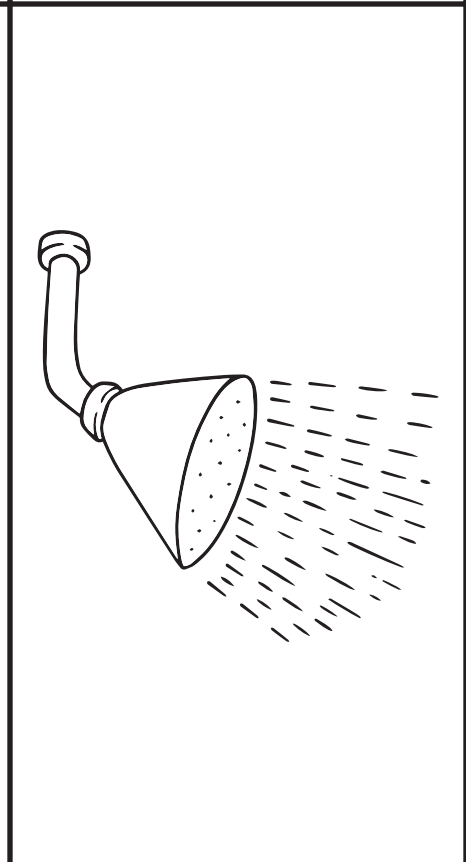
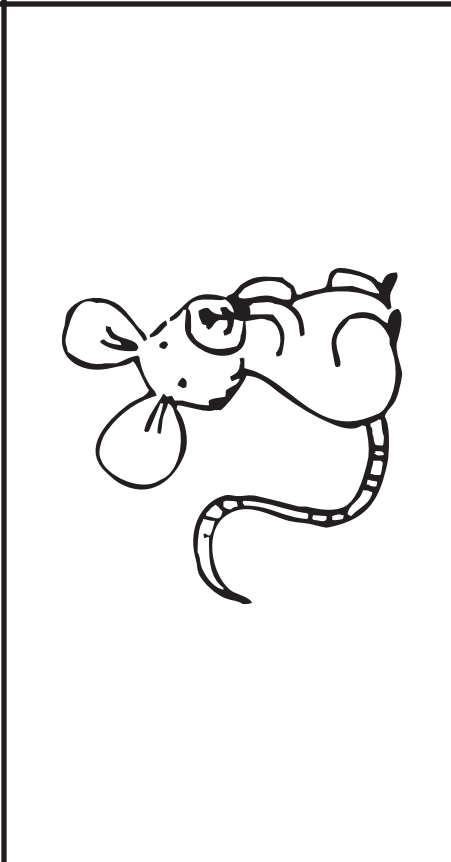
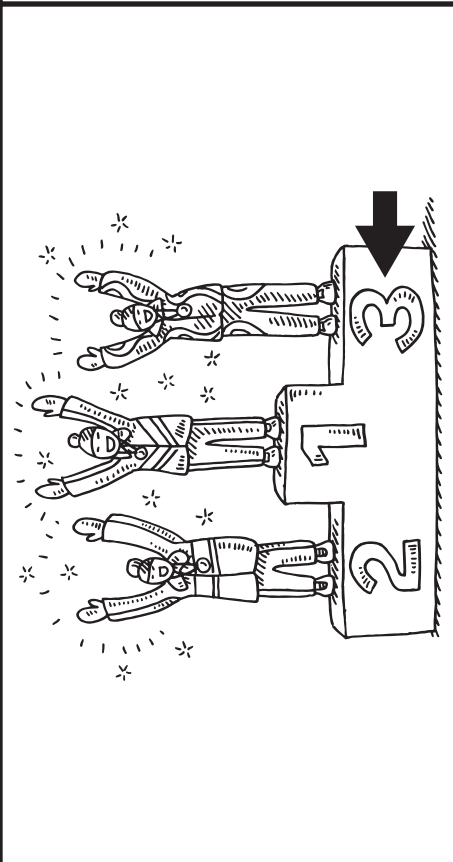
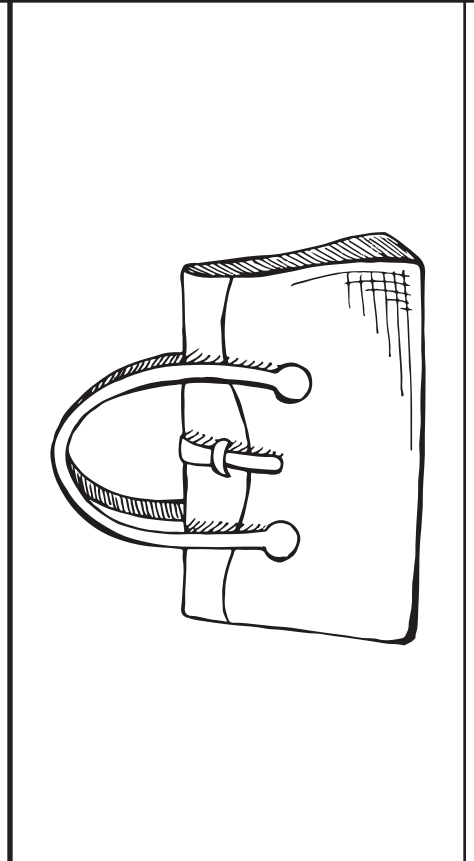
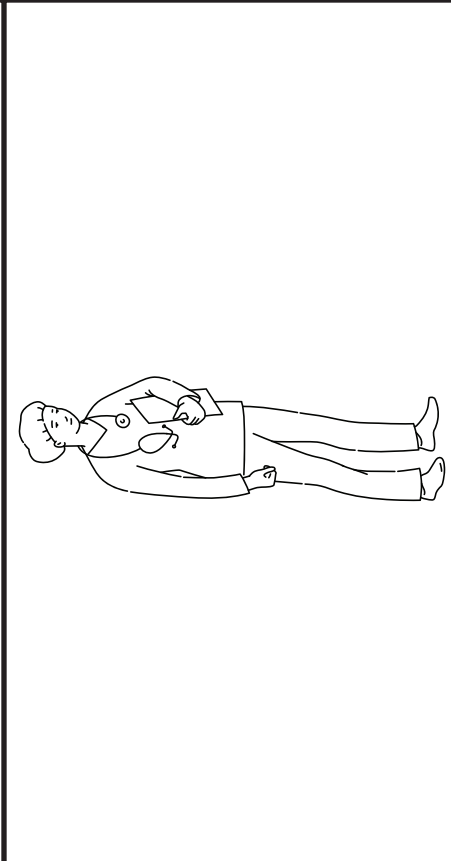

surf, nurse, purse, third, mouse, shower



# Phonics

Letter-Sound Match

P. 025

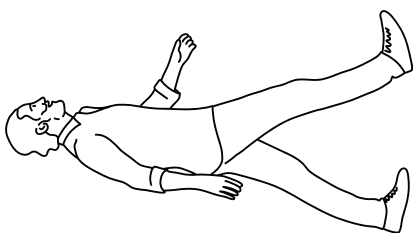
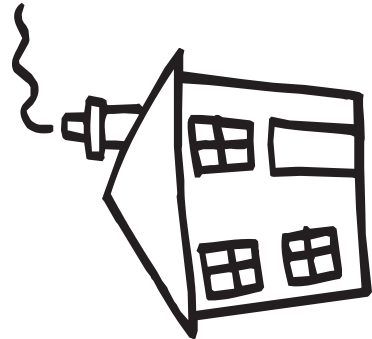
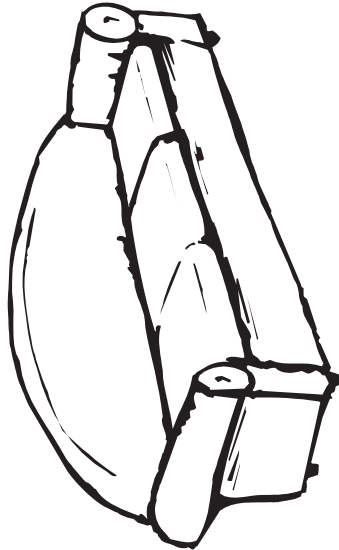
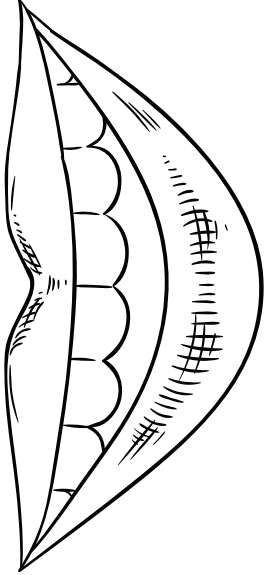

mouth, couch, house, walk, chalk, yawn



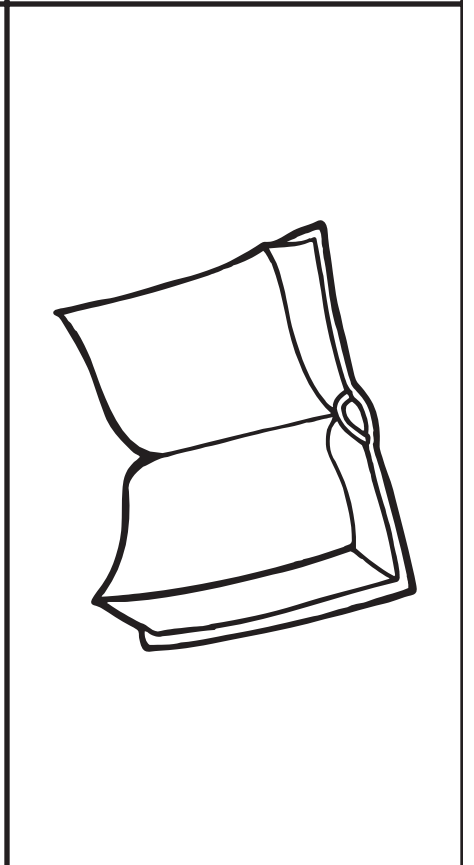
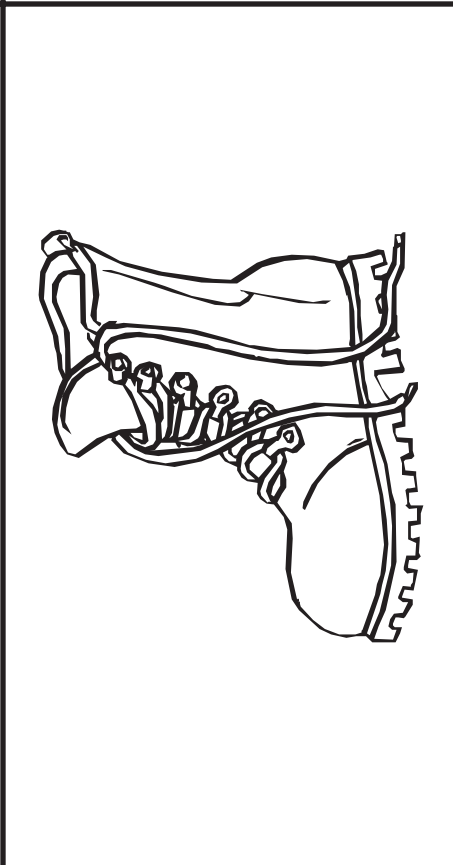
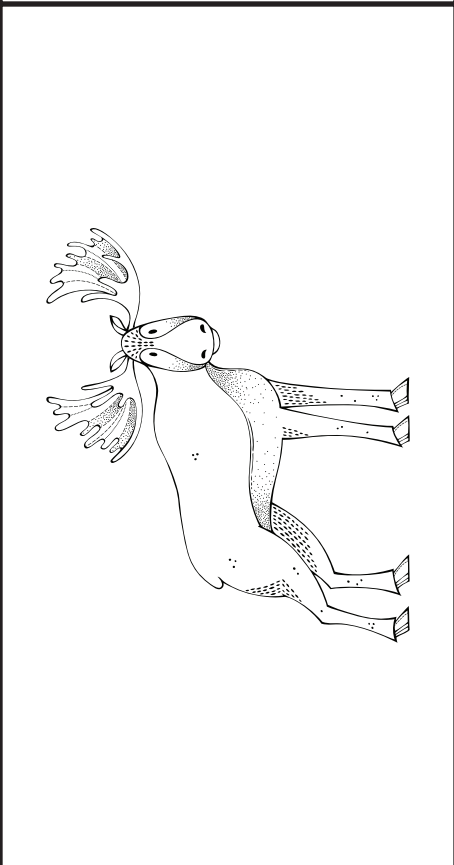
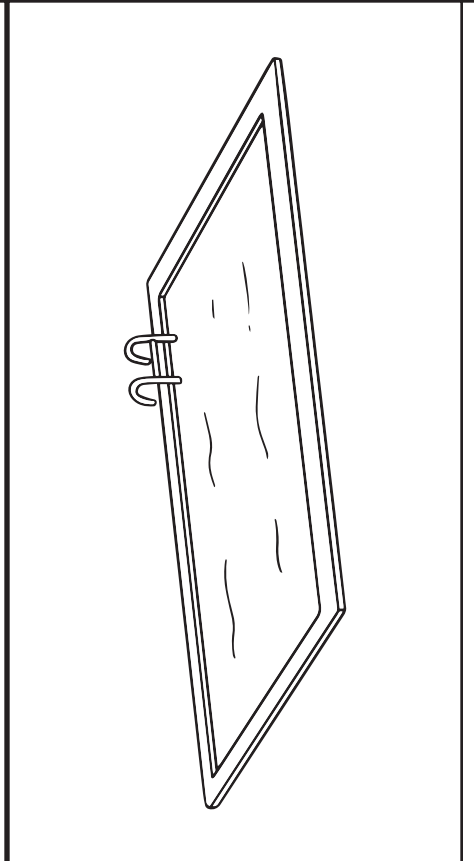
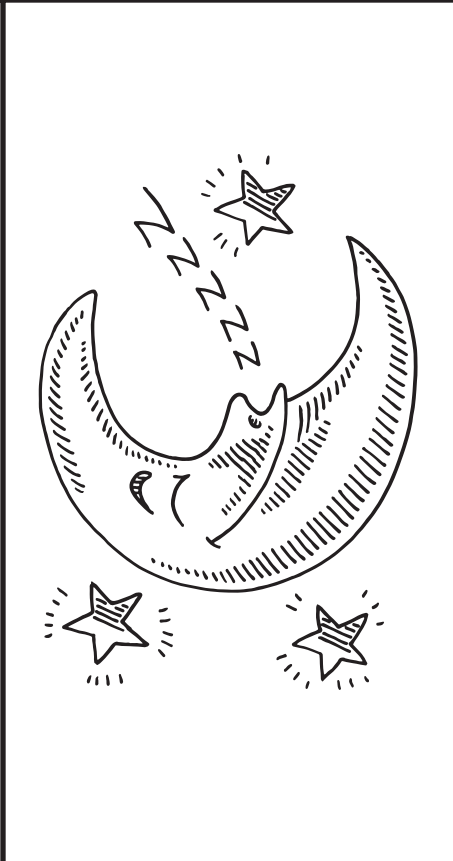
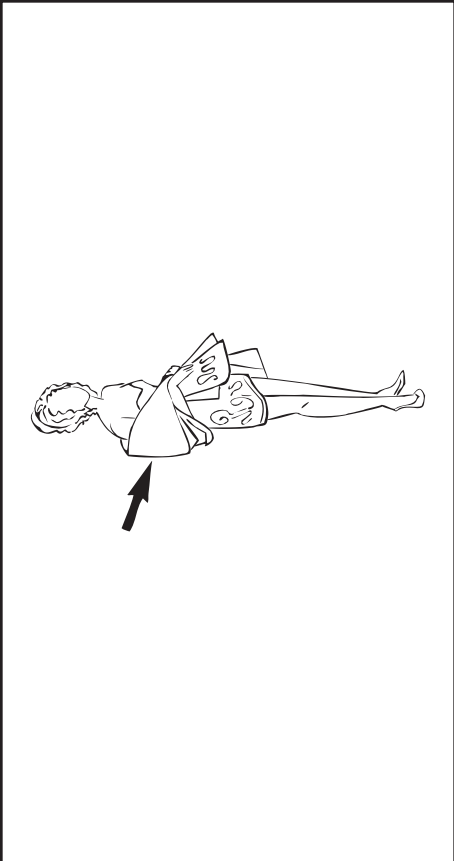

shawl, moon, pool, moose, boot, book



# Phonics

Letter-Sound Match

P. 025

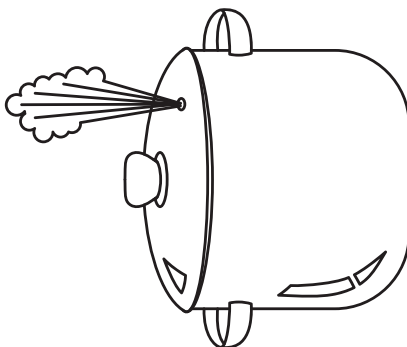
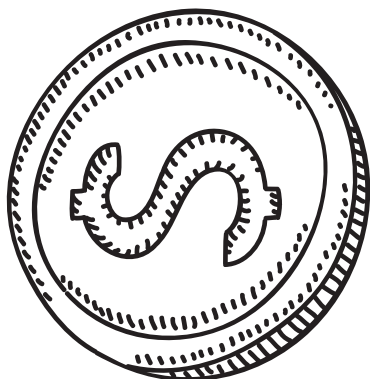
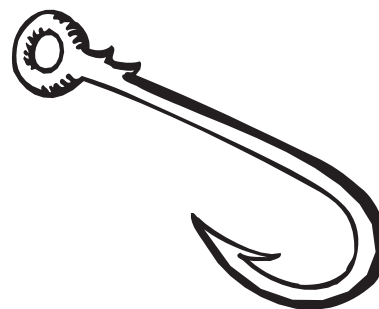
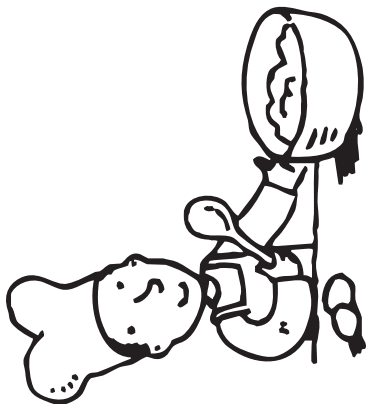

cook, foot, hook, coin, boil



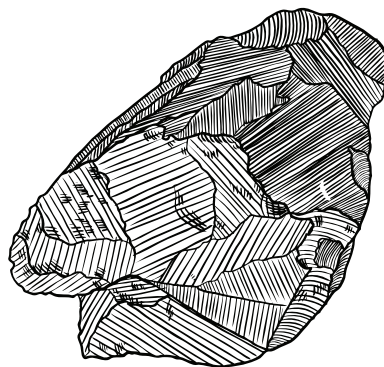
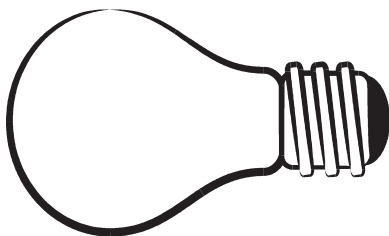
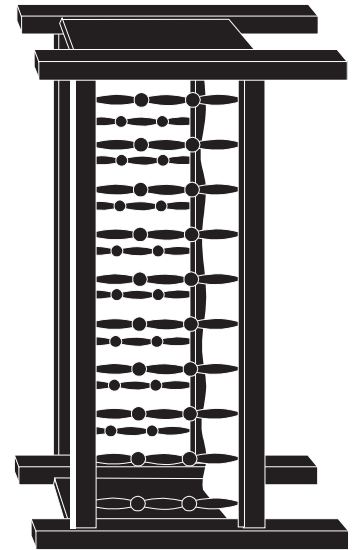
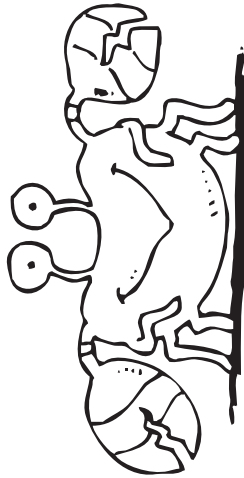
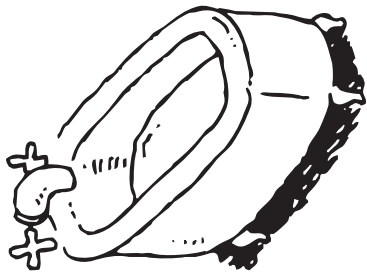

tub, crab, crib, bulb, rock, milk





# Phonics

Letter-Sound Match

P. 025

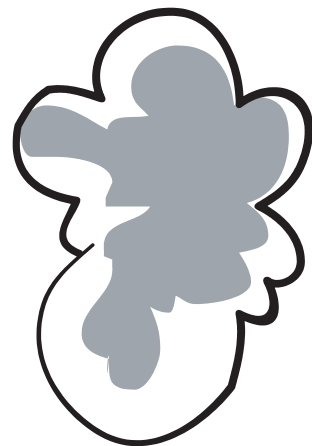
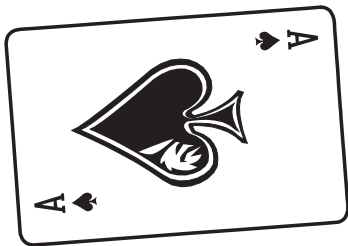
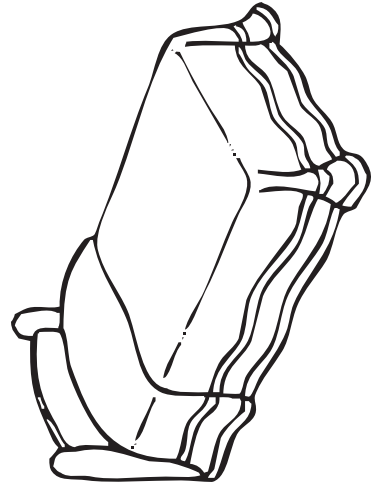
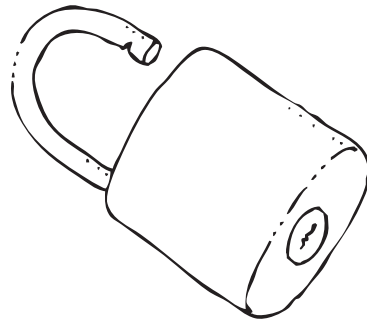
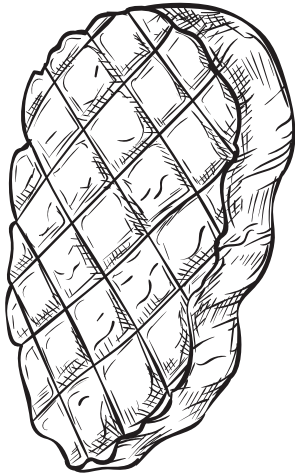

steak, lock, bed, card, bird, cloud



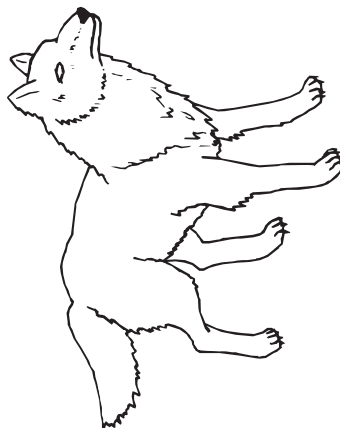
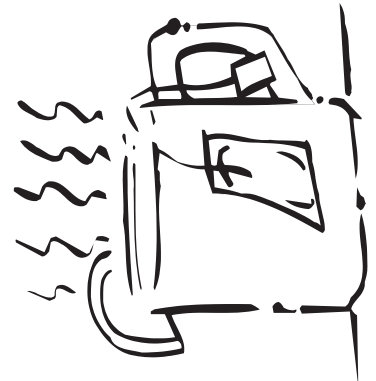

cookie, pea, tea, penny, wolf, elf



# Phonics

Letter-Sound Match

P. 025

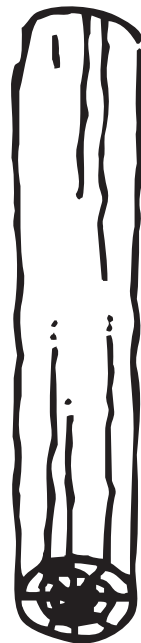
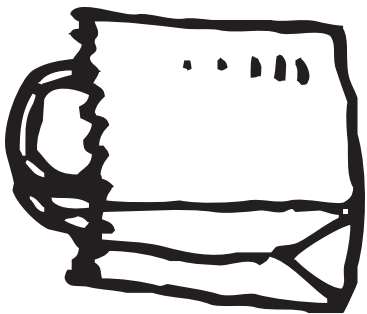
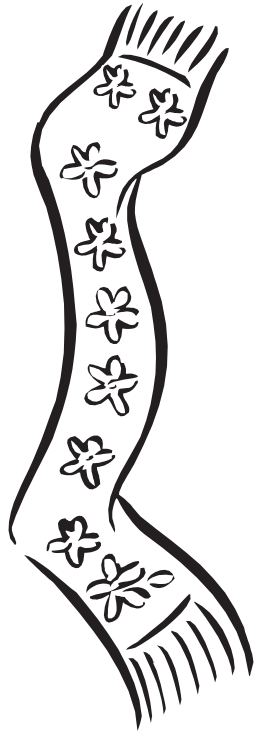
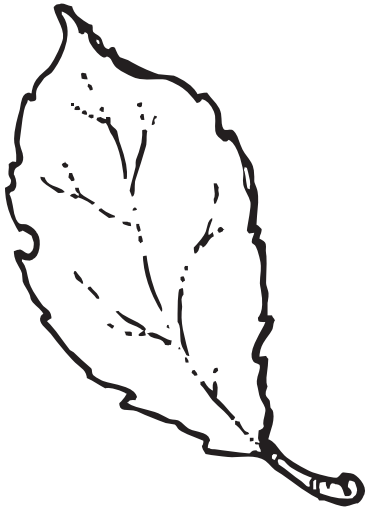

leaf, scarf, bug, bag, frog, log



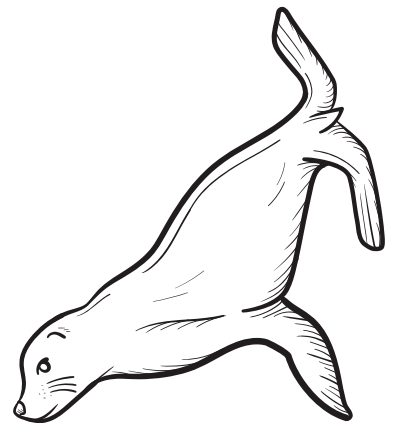
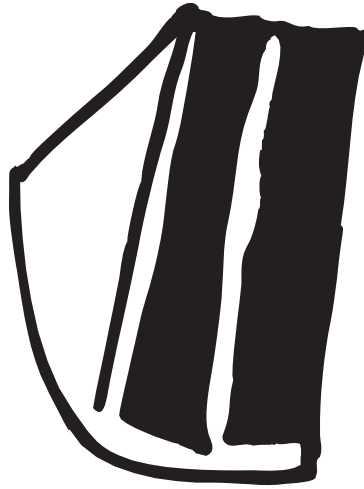
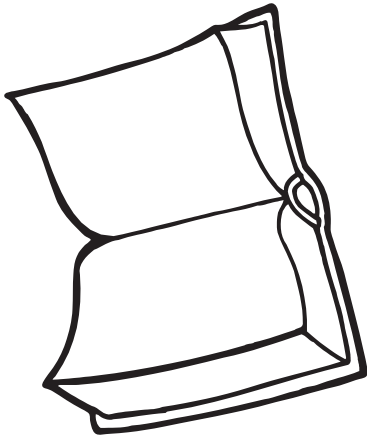

book, cake, stick, school, shovel, seal



# Phonics

Letter-Sound Match

P. 025

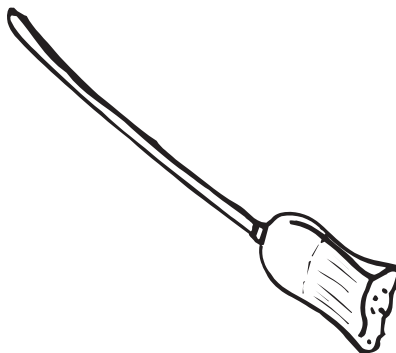
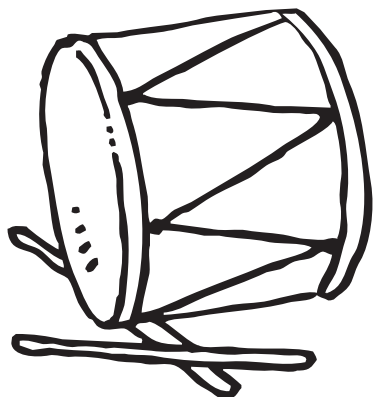
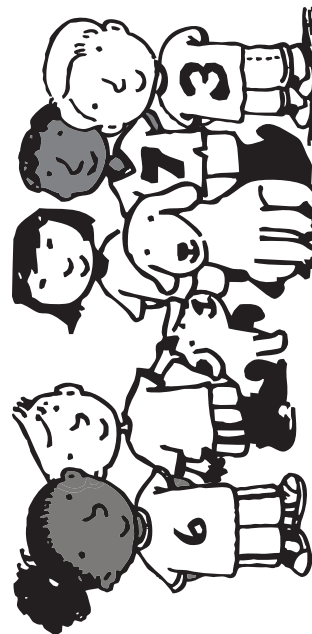
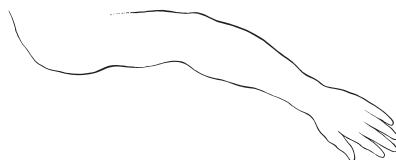
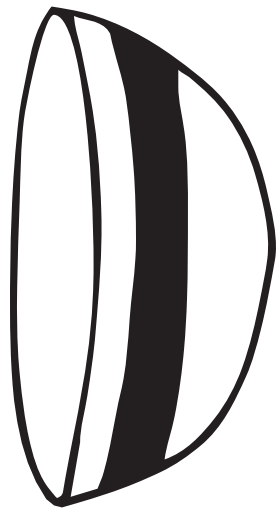

7

bowl, arm, team, drum, broom, seven



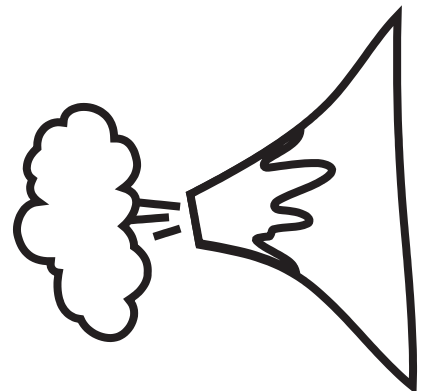
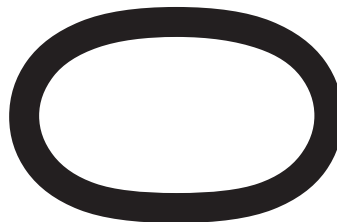
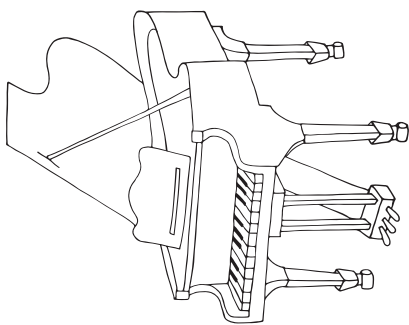
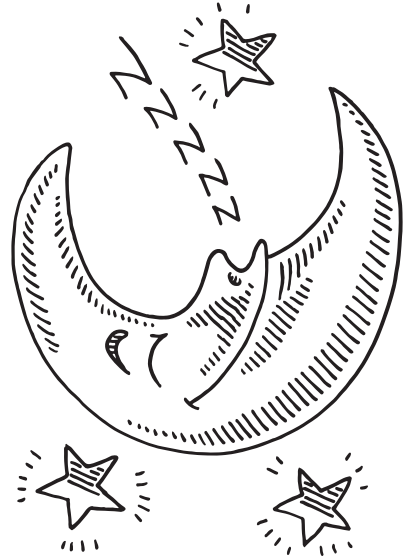
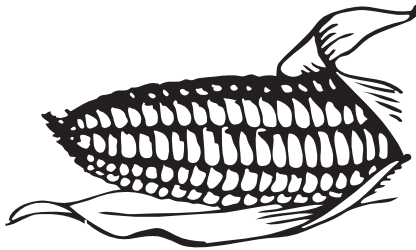
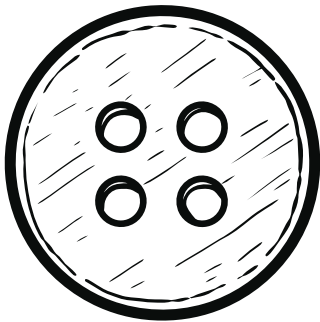

button, corn, moon, piano, zero, volcano



# Phonics

Letter-Sound Match

P. 025

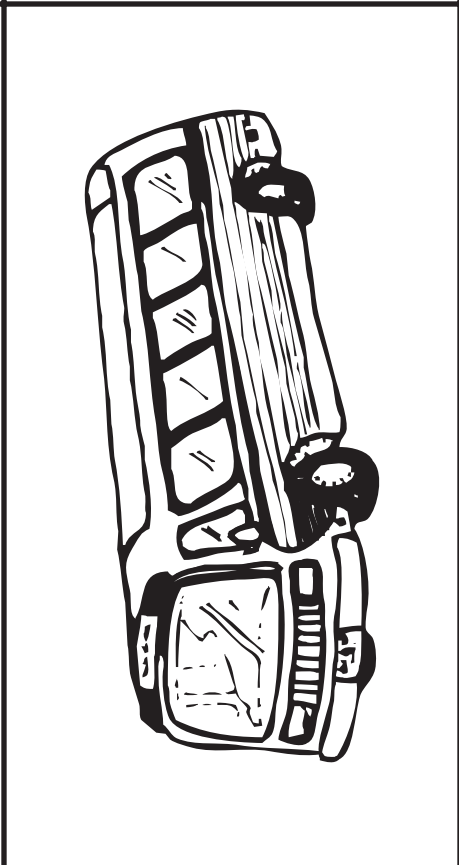
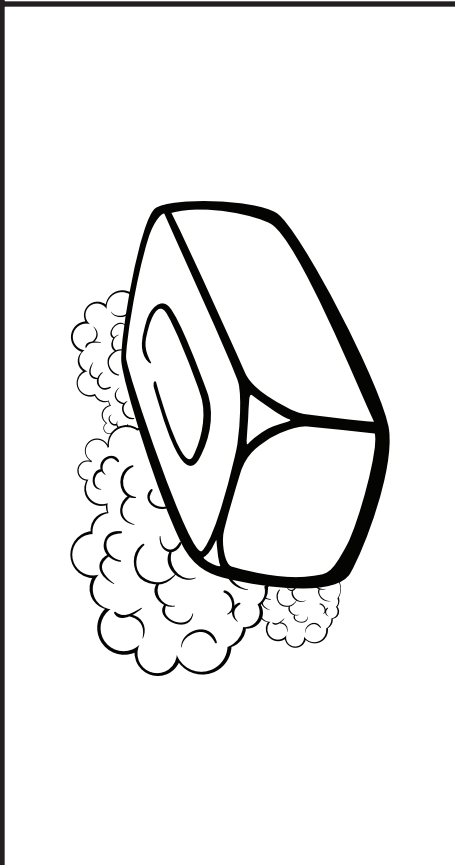
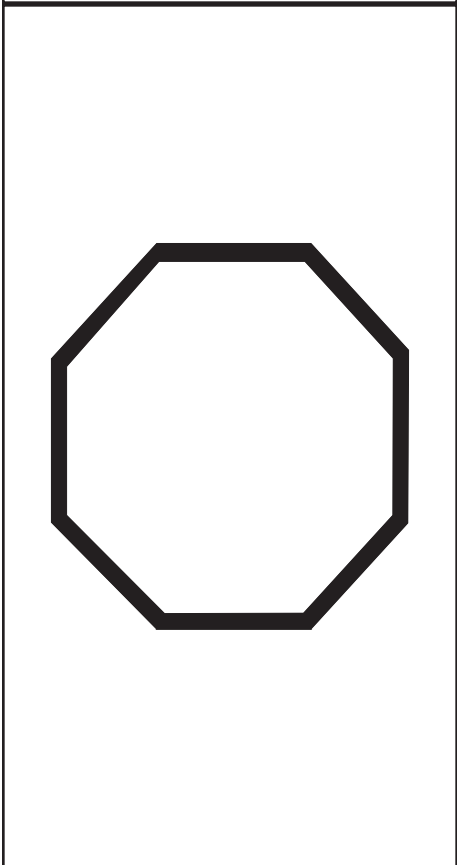
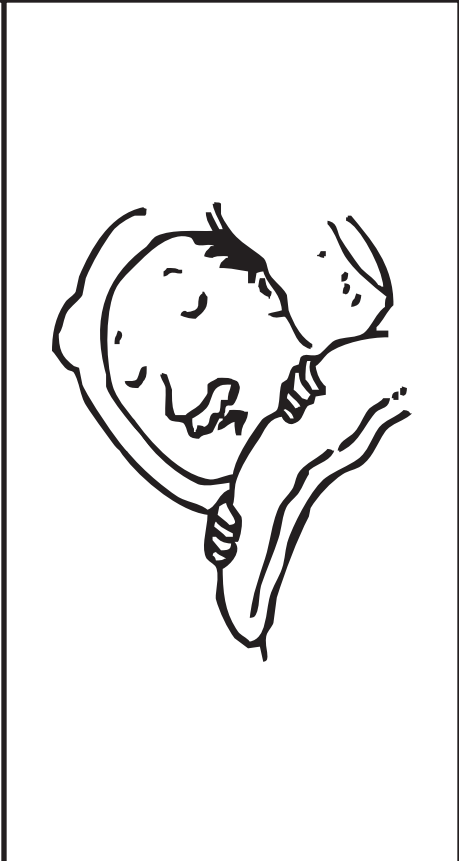
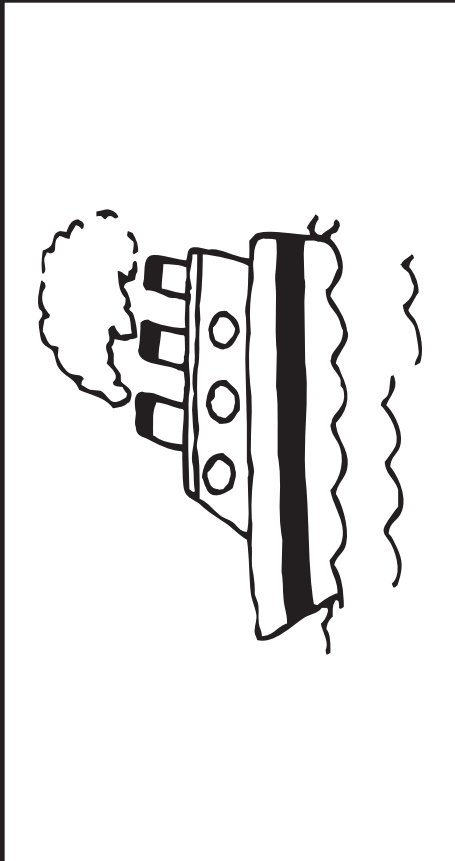
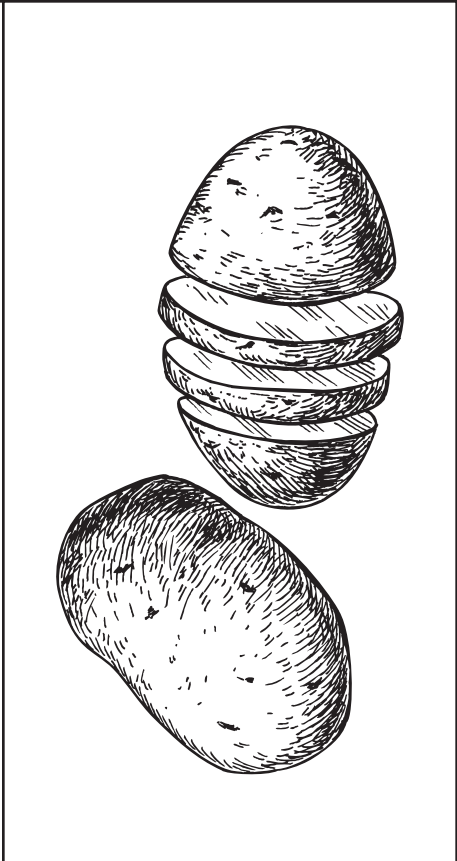

potato, ship, sleep, stop, soap, bus



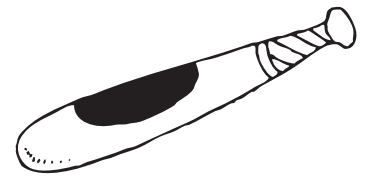
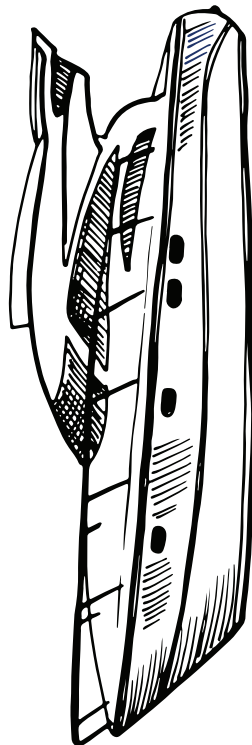
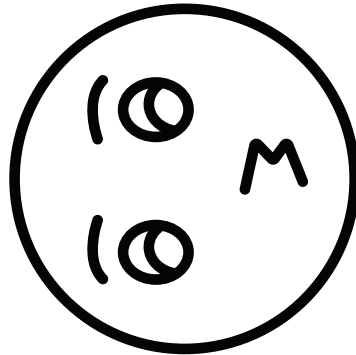
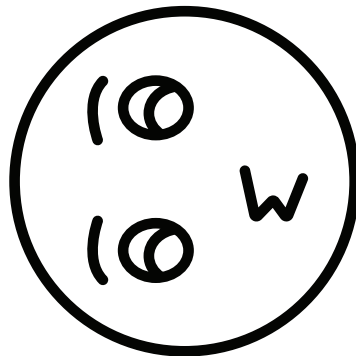
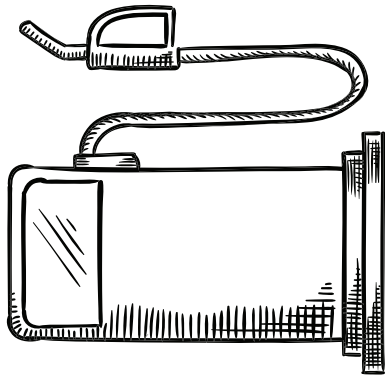

gas, kiss, octopus, carrot, boat, bat





# Phonics

Letter-Sound Match

P. 025

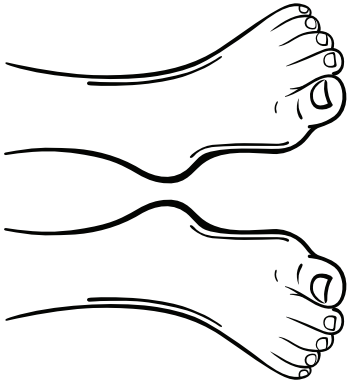

5

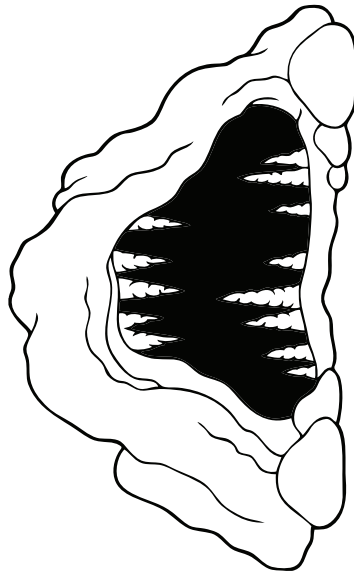
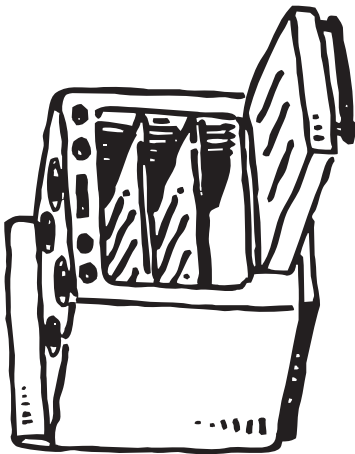

feet, five, sleeve, stove, cave, ox



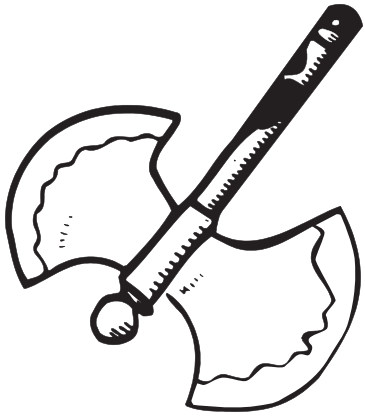

6

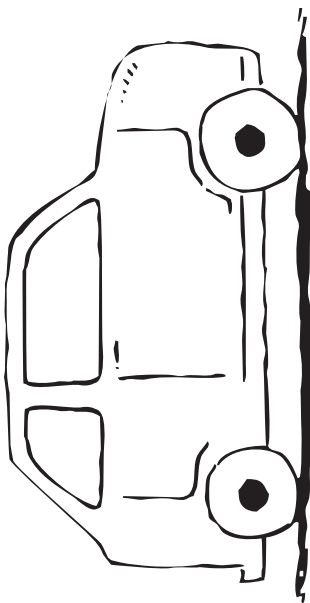
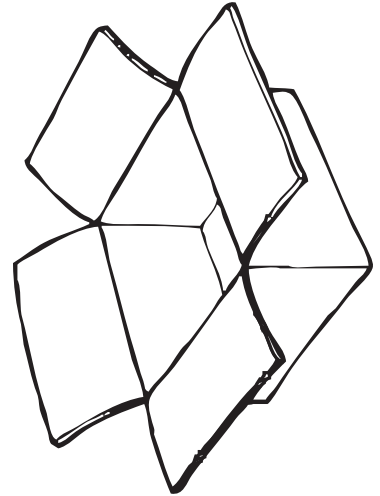

ax, six, box, car, star, jar



# Phonics

Letter-Sound Match

P. 025

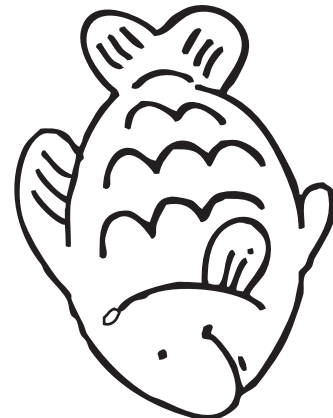
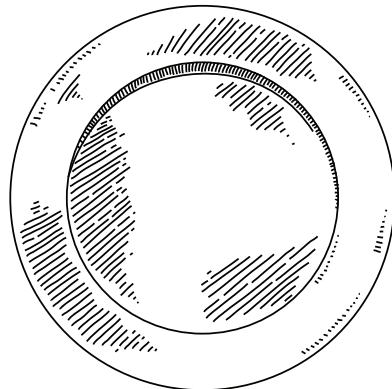
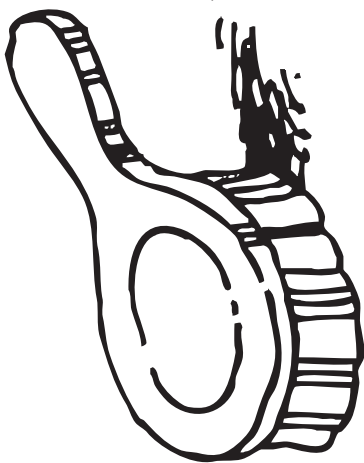
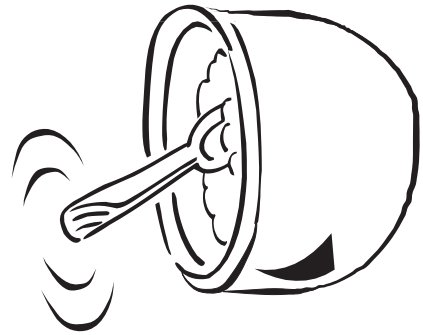
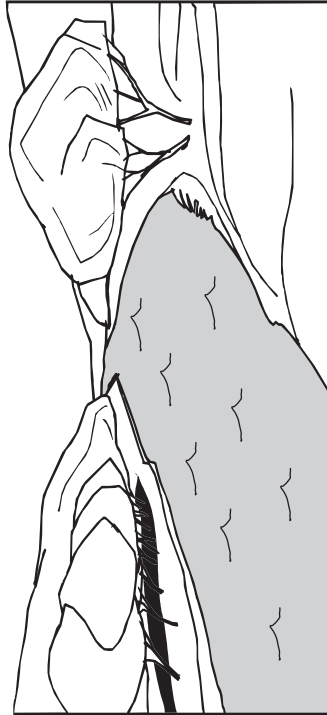
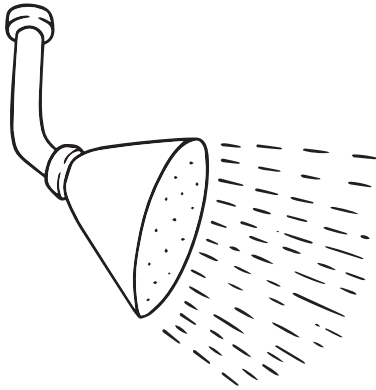

shower, river, stir, brush, dish, fish



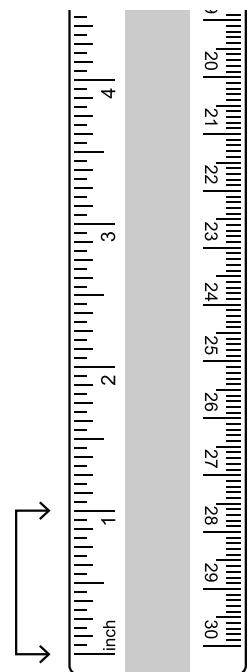
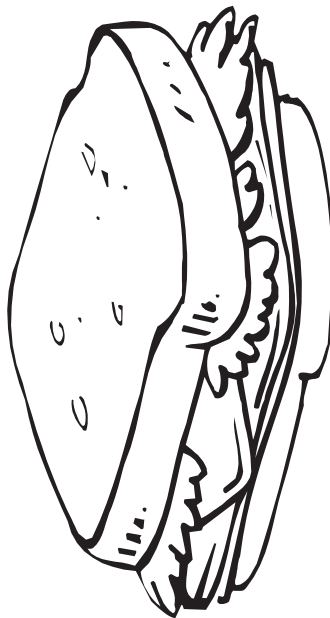
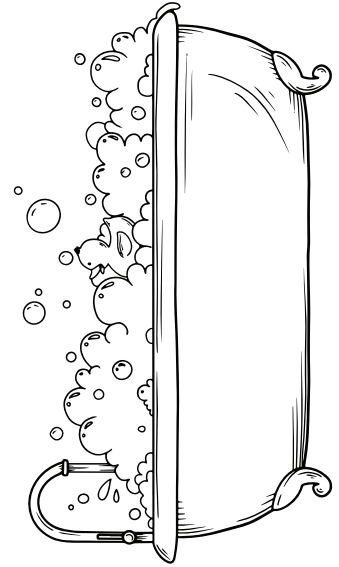
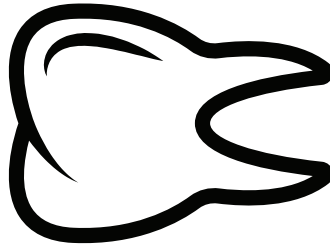
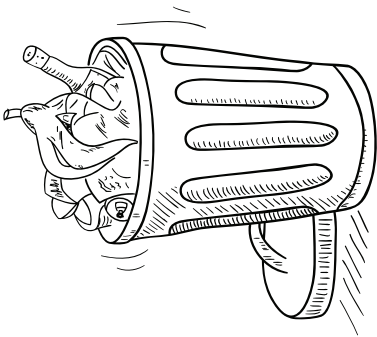

trash, tooth, bath, watch, sandwich, inch



# Phonics

Letter-Sound Match

P. 025

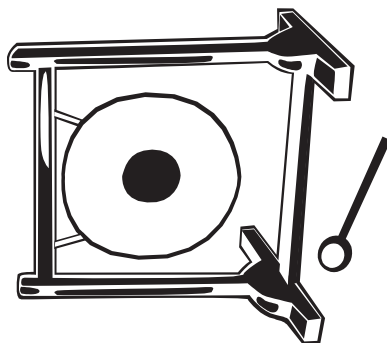
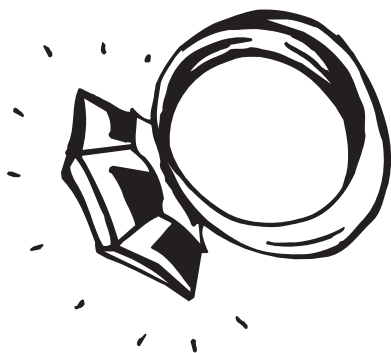
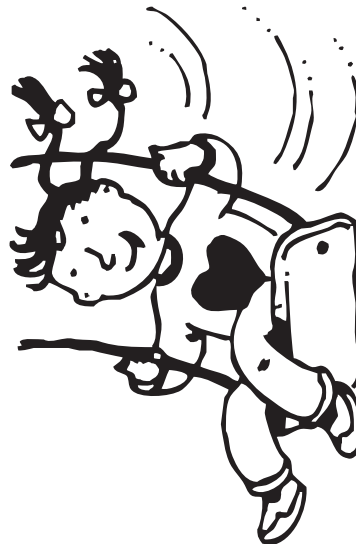
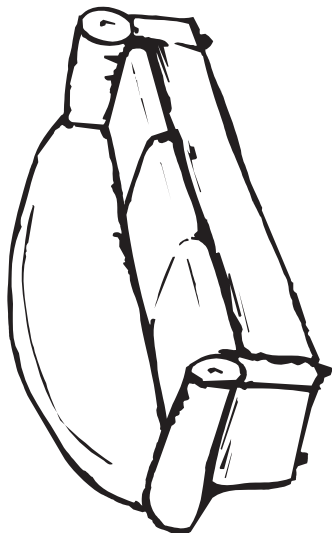

couch, king, swing, ring, gong, cow



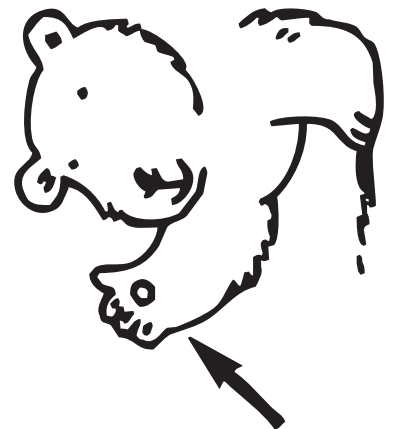
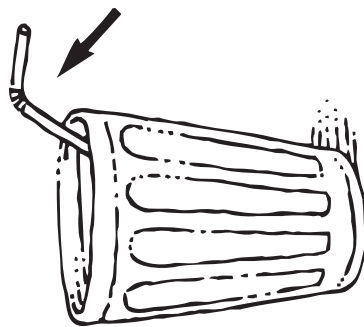
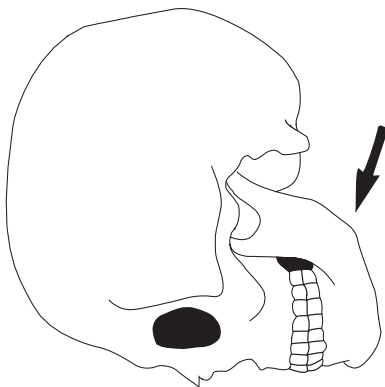
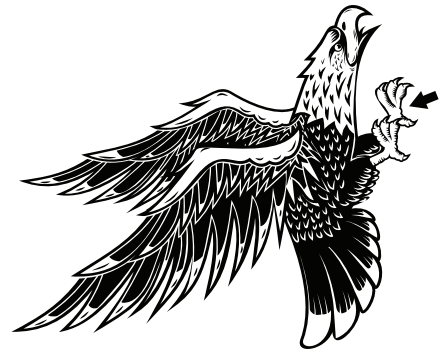
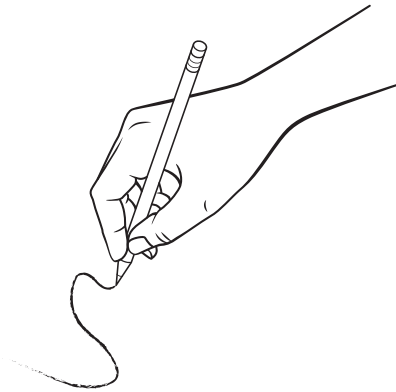

plow, draw, claw, jaw, straw, paw



# Phonics

Letter-Sound Match

P. 025

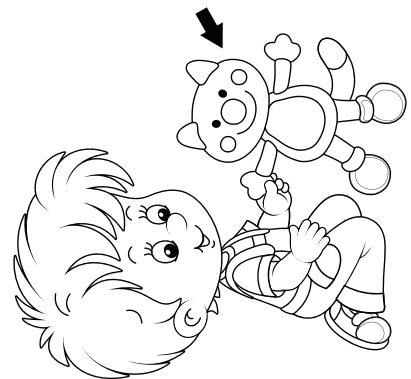
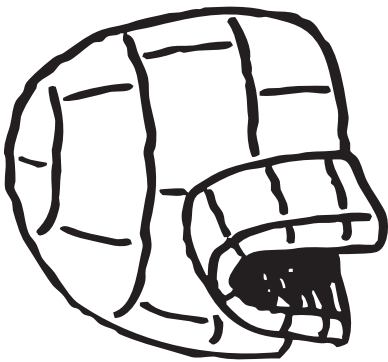
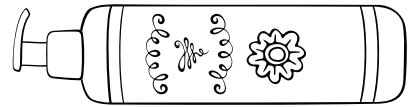
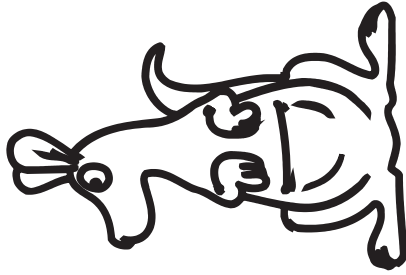

zoo, kangaroo, shampoo, igloo, boy, toy

